

EPA/600/R-06/129F
May 2009

**METABOLICALLY DERIVED HUMAN VENTILATION RATES: A
REVISED APPROACH BASED UPON OXYGEN CONSUMPTION RATES**

National Center for Environmental Assessment
Office of Research and Development
U.S. Environmental Protection Agency
Washington, DC 20460

DISCLAIMER

This document has been reviewed in accordance with U.S. Environmental Protection Agency policy and approved for publication. Mention of trade names or commercial products does not constitute endorsement or recommendation for use.

ABSTRACT

The U.S. Environmental Protection Agency's (EPA's) National Center for Environmental Assessment (NCEA) publishes the *Exposure Factors Handbook* and the *Child-Specific Exposure Factors Handbook* to provide risk assessors with data on various factors that can impact an individual's exposure to environmental contaminants. Both of these handbooks included estimates of ventilation rate (\dot{V}_E)—the volume of air that is inhaled by an individual in a specified time period. Previous approach to calculate \dot{V}_E is limited by its dependence on a “ventilatory equivalent” which, in turn, relies on a person's fitness level. In this document, U.S. EPA presents a revised approach in which \dot{V}_E is calculated directly from an individual's oxygen consumption rate. U.S. EPA then applies this method to data provided from more recent sources: the 1999–2002 National Health and Nutrition Examination Survey (NHANES) and U.S. EPA's Consolidated Human Activity Database (CHAD).

Preferred Citation:

U.S. Environmental Protection Agency (EPA). (2009) Metabolically derived human ventilation rates: a revised approach based upon oxygen consumption rates. National Center for Environmental Assessment, Washington, DC; EPA/600/R-06/129F.

CONTENTS

LIST OF TABLES.....	v
LIST OF ABBREVIATIONS AND ACRONYMS	vi
PREFACE.....	vii
AUTHORS, CONTRIBUTORS, AND REVIEWERS	viii
EXECUTIVE SUMMARY	ix
1. BACKGROUND AND OBJECTIVES	1-1
2. DATA SOURCES	2-1
2.1. SOURCE OF BODY WEIGHT DATA: 1999–2002 NHANES.....	2-1
2.2. SOURCE OF BMR CALCULATION: SCHOFIELD (1985).....	2-3
2.3. SOURCE OF ACTIVITY AND METS DATA: CONSOLIDATED HUMAN ACTIVITY DATABASE (CHAD)	2-4
2.3.1. The National Human Activity Pattern Survey.....	2-5
3. APPROACH.....	3-1
3.1. STEP 1: GROUP NHANES AND NHAPS PARTICIPANTS BY AGE AND GENDER CATEGORIES	3-2
3.2. STEP 2: CALCULATE BMR ESTIMATES FOR NHANES PARTICIPANTS	3-2
3.3. STEP 3: GENERATE A SIMULATED 24-HOUR ACTIVITY PATTERN FOR EACH NHANES PARTICIPANT.....	3-2
3.4. STEP 4: GENERATE A METS VALUE FOR EACH ACTIVITY WITHIN THE SIMULATED 24-HOUR ACTIVITY PATTERN FOR EACH NHANES PARTICIPANT.....	3-4
3.5. STEP 5: CALCULATE ENERGY EXPENDITURE AND VO_2 FOR EACH ACTIVITY WITHIN AN INDIVIDUAL’S SIMULATED 24-HOUR ACTIVITY PATTERN.....	3-6
3.6. STEP 6: CALCULATE VENTILATION RATE FOR EACH ACTIVITY WITHIN THE SIMULATED 24-HOUR ACTIVITY PATTERN FOR EACH NHANES PARTICIPANT	3-7
3.7. STEP 7: CALCULATE AVERAGE VENTILATION RATE FOR TIME SPENT PERFORMING ACTIVITIES WITHIN SPECIFIED METS CATEGORIES, AS WELL AS 24-HOUR AVERAGE VENTILATION RATE, FOR EACH NHANES PARTICIPANT.....	3-9
3.8. STEP 8: CALCULATE SUMMARY TABLES ACROSS INDIVIDUALS.....	3-10
4. RESULTS	4-1
4.1. STRENGTHS AND LIMITATIONS	4-11
REFERENCES	R-1

CONTENTS (continued)

APPENDIX A: REVISED VENTILATION RATE (VE) EQUATIONS FOR USE IN
INHALATION-ORIENTED EXPOSURE MODELS A-1

APPENDIX B: STATISTICAL DISTRIBUTIONS ASSIGNED TO ACTIVITY
CODES FOR USE IN SIMULATING METS VALUES.....B-1

APPENDIX C: ADDITIONAL ANALYSIS TABLESC-1

APPENDIX D: RESPONSE PREPARED BY S. GRAHAM (U.S. EPA) TO PEER
REVIEWER COMMENTS ON APPENDIX A..... D-1

LIST OF TABLES

2-1.	Numbers of individuals from NHANES 1999–2002 with available age, gender, and body weight data, by age and gender categories.....	2-2
2-2.	Equations from Schofield (1985) that predict BMR (MJ/day) as a function of body weight (BW, kg).....	2-3
2-3.	Numbers of individuals from the NHAPS study by age and gender categories.....	2-7
3-1.	Maximum possible METS values assigned to children, by age and gender.....	3-6
3-2.	Estimated values, by age range, of the parameters within the multiple linear regression model for predicting body-weight adjusted ventilation rate (\dot{V}_E/BW ; L/min-kg).....	3-7
3-3.	Estimated values, by age range, of the parameters within the mixed effects regression model for predicting body-weight adjusted ventilation rate (\dot{V}_E/BW ; L/min-kg).....	3-9
4-1a.	Descriptive statistics for daily average ventilation rate (L/min) in males, by age category.....	4-3
4-1b.	Descriptive statistics for daily average ventilation rate (L/min) in females, by age category.....	4-4
4-2a.	Average time spent per day performing activities within specified intensity categories, and average ventilation rates associated with these activity categories, for males according to age category	4-5
4-2b.	Average time spent per day performing activities within specified intensity categories, and average ventilation rates associated with these activity categories, for females according to age category	4-8

LIST OF ABBREVIATIONS AND ACRONYMS

APEX	Air Pollution Exposure
BMR	basal metabolic rate
CDC	Centers for Disease Control and Prevention
CHAD	Consolidated Human Activity Database
EE	energy expenditure
EPA	U.S. Environmental Protection Agency
<i>H</i>	oxygen uptake
METS	metabolic equivalent
NERL	National Exposure Research Laboratory
NHANES	National Health and Nutrition Examination Survey
NHAPS	National Human Activity Pattern Survey
SHEDS	Stochastic Human Exposure and Dose Simulation
USDA	U.S. Department of Agriculture
\dot{V}_E	ventilation rate
VO ₂	oxygen consumption rate
VQ	ventilatory equivalents

PREFACE

The Exposure Factors Program of the U.S. Environmental Protection Agency's (EPA's) Office of Research and Development (ORD) has three main goals: (1) provide updates to the *Exposure Factors Handbook and the Child-Specific Exposure Factors Handbook*; (2) identify data gaps in exposure factors and needs in consultation with clients; and (3) develop companion documents to assist clients in the use of exposure factors' data. The activities under each goal are supported by and respond to the needs of the various program offices.

ORD's National Center for Environmental Assessment (NCEA) published the *Exposure Factors Handbook* in 1997 and the *Child-Specific Exposure Factors Handbook* in 2008. These documents provide summaries of available statistical data on various factors impacting an individual's exposure to environmental contaminants. NCEA maintains these handbooks and periodically updates them using current literature and other reliable data made available through research. This document, *Metabolically Derived Human Ventilation Rates: A Revised Approach Based Upon Oxygen Consumption Rates*, provides information that can be used to update the ventilation rate values in the next editions of the *Exposure Factors Handbook* and the *Child-Specific Exposure Factors Handbook*.

AUTHORS, CONTRIBUTORS, AND REVIEWERS

The National Center for Environmental Assessment (NCEA), Office of Research and Development was responsible for the preparation of this document. The document was prepared by Battelle under U.S. EPA Contract No. EP-C-04-027. Laurie Schuda served as Work Assignment Manager, providing overall direction, technical assistance, and serving as contributing author.

AUTHORS

Battelle

Bob Lordo
Jessica Sanford
Marcie Mohnson

U.S. EPA

Laurie Schuda
Jacqueline Moya
Tom McCurdy (Appendix A)
Steven Graham (Appendices A and D)

The following U.S. EPA individuals reviewed an earlier draft of this document and provided valuable comments:

Bob Benson, U.S. EPA, Region 8
Brenda Foos, U.S. EPA, Office of Children's Health Protection
Gary Foureman, U.S. EPA, National Center for Environmental Assessment
Deirdre Murphy, U.S. EPA, Office of Air Quality Planning and Standards
Harvey Richmond, U.S. EPA, Office of Air Quality Planning and Standards
John Schaum, U.S. EPA, National Center for Environmental Assessment
Michel Stevens, U.S. EPA, National Center for Environmental Assessment
Paul White, U.S. EPA, National Center for Environmental Assessment

An external panel of experts serving as peer reviewers, along with experts representing the general public, reviewed this document (i.e., the main document and Appendices A through C). The peer-review panel was composed of the following individuals:

Dr. William C. Adams (Chair), Professor Emeritus, University of California, Davis
Dr. Amy Arcus-Arth, Office of Environmental Health Hazard Assessment, Cal/EPA
Dr. David W. Layton (Chair), University of California, Retired.

EXECUTIVE SUMMARY

The U.S. Environmental Protection Agency's (EPA's) National Center for Environmental Assessment (NCEA) published the *Exposure Factors Handbook* and the *Child-Specific Exposure Factors Handbook* to provide data on various factors impacting an individual's exposure to environmental contaminants. The two primary purposes of these handbooks are (1) to summarize data on human behaviors and characteristics that can affect exposure to environmental contaminants, and (2) to recommend values for specific exposure factors when included within an exposure assessment. NCEA maintains the *Exposure Factors Handbook* and the *Child-Specific Exposure Factors Handbook* and periodically updates them using current literature and other reliable data made available through research. Many program offices (e.g., Office of Solid Waste and Emergency Response, Office of Pesticides and Toxic Substances, Office of Water) within U.S. EPA rely on the data from these handbooks to conduct their exposure and risk assessments.

The *Exposure Factors Handbook* was first published in 1997 and the *Child-Specific Exposure Factors Handbook* in 2008, and the data presented in the handbooks have been compiled from various sources, including government reports and information presented in the scientific literature. Among the exposure factors addressed by these handbooks are drinking water consumption, soil ingestion, inhalation rates, dermal factors, food consumption, breast milk intake, human activity factors, consumer product use, and residential characteristics. These exposure factors represent the general population as well as specific target populations that may have differing characteristics from those of the general population.

One important determinant of a person's exposure to contaminants in air is the ventilation rate (\dot{V}_E), or the volume of air that is inhaled by an individual in a specified time period. \dot{V}_E s, also known as breathing or inhalation rates, are given in Chapter 6 of the *Exposure Factors Handbook* and the *Child-Specific Exposure Factors Handbook*. Ventilation rates have been calculated in the past indirectly using estimates of "ventilatory equivalent," or the ratio of the volume of air ventilating the lungs to the volume of oxygen consumed. Past methodologies have not taken into account the variability in ventilatory equivalent with regard to age, gender, and fitness level.

This document, *Metabolically Derived Human Ventilation Rates: A Revised Approach Based Upon Oxygen Consumption Rates* presents a revised approach that calculates \dot{V}_E s directly from an individual's oxygen consumption rate (VO_2) and applies this method to data provided from more recent sources—the 1999–2002 National Health and Nutrition Examination Survey (NHANES) and U.S. EPA's Consolidated Human Activity Database (CHAD). This new approach considers variability due to age, gender, and activities. Data were grouped into age categories and a simulated 24-hour activity pattern was generated by randomly sampling activity patterns from the set of participants with the same gender and age. Each activity was assigned a metabolic equivalent (METs) value based on statistical sampling of the distribution assigned by CHAD to each activity code. Using statistical software, equations for METs based on normal, lognormal, exponential, triangular, and uniform distributions were generated as needed for the various activity codes. The METs values were then translated into energy expenditure (EE) by multiplying the METs by the basal metabolic rate (BMR), which was calculated as a linear function of body weight. The VO_2 was calculated by multiplying EE by H, the volume of oxygen consumed per unit of energy. VO_2 was calculated both as volume per time and as volume per time per unit body weight.

The inhalation rate for each activity within the 24-hour simulated activity pattern for each individual was estimated as a function of VO_2 , body weight, age, and gender. Following this, the average inhalation rate was calculated for each individual for the entire 24-hour period, as well as for four separate classes of activities based on METs value (sedentary/passive [METs less than or equal to 1.5], light intensity [METs greater than 1.5 and less than or equal to 3.0], moderate intensity [METs greater than 3.0 and less than or equal to 6.0], and high intensity [METs greater than 6.0]). Data for individuals were then used to generate summary tables with distributional data based on gender and age categories. Mean long-term inhalation rates, presented as daily rates for children and adults, ranged from 8.76-20.93 m^3/day for males (Table C-2a) and 8.53-16.20 m^3/day for females (Table C-2b) with the lowest value corresponding to children birth to <1 year and the highest value to adults 41 to <51 years. Mean short-term inhalation rates, determined for children and adults performing various activities, ranged from 3.0×10^{-03} - 5.8×10^{-02} m^3/minute (Table C-6) with the lowest value corresponding to male children birth to <1 year sleeping or napping and the highest value for male adults 51 to <61 years of age during high-intensity activities.

A validation exercise was conducted to compare results presented in this document with values published in the literature using two other methodologies. These methodologies include the use of doubly labeled water for estimating EE (Brochu et al., 2006a, b) and the use of food-energy intakes from nationwide food intake surveys to estimate EEs (Layton, 1993; Arcus-Arth and Blaisdell, 2007). U.S. EPA has implemented the methodology presented in this document in Appendix A within the inhalation modules of population-based probabilistic exposure models, including the Stochastic Human Exposure and Dose Simulation (SHEDS) model and the Air Pollution Exposure (APEX) model. The APEX model results were then compared with the values reported by Brochu et al. (2006a, b) and Arcus-Arth and Blaisdell (2007) and are presented in Appendix D. Mean estimates for all of the physiological parameters generated by APEX, including \dot{V}_E s, are reasonably correlated with independent measures from the Brochu et al. (2006a, b) estimates—particularly when correcting the Brochu et al. (2006a) ventilation estimates for children using a more appropriate estimate of ventilatory equivalents (VQ) for children. The comparisons offer a validation of the methodology presented in this document and show that despite the different methodologies and data sources, the resulting APEX-derived mean ventilation estimates compare favorably to those of these two other methods. Although the three methodologies available to estimate \dot{V}_E s (i.e., doubly labeled water, food-energy consumption, and metabolically-derived \dot{V}_E s) have different strengths and limitations, they complement each other in providing useful information on \dot{V}_E s. It should be noted, however, that upper percentile values estimated using the metabolically derived daily \dot{V}_E s methodology may be more uncertain. These values tend to equate to unusually high estimates of caloric intake per day and are unlikely to represent an average individual.

The comprehensive analysis of \dot{V}_E s presented in this document for the four separate classes of activities based on METS value (i.e., sedentary/passive, light intensity, moderate intensity, and high intensity) for the age categories for both children and adults, males and females, is unique and is not currently available in the literature. These estimates of \dot{V}_E s and their variability with age and gender are important parameters in the estimation of the inhaled dose and deposition of contaminants along the respiratory tract.

1. BACKGROUND AND OBJECTIVES

The U.S. Environmental Protection Agency (EPA) and its program offices conduct various types of exposure assessment activities to characterize human exposure to toxic chemicals. To assist in these efforts, U.S. EPA's National Center for Environmental Assessment has developed the *Exposure Factors Handbook* (U.S. EPA, 1997) and the *Child-Specific Exposure Factors Handbook* (U.S. EPA, 2008), documents that provide a summary of available statistical data on various factors that can impact a person's exposure to environmental contaminants. The two primary purposes of the handbooks are

- to summarize data on human behaviors and characteristics that can affect exposure to environmental contaminants, and
- to recommend values for specific exposure factors when included within an exposure assessment.

The exposure factors addressed by the handbooks include drinking water consumption, soil ingestion, inhalation rates, dermal factors including skin area and soil adherence factors, food consumption, breast milk intake, human activity factors, consumer product use, and residential characteristics. Values documented in the handbooks for these exposure factors represent the general population as well as specific target populations. The handbooks are a compilation of information obtained from a variety of different sources and studies that are presented in a consistent manner, while retaining much of the original formats that the individual study authors used in their publications. Exposure assessors are the primary intended audience—with a particular focus placed on researchers requiring data on standard factors to calculate human exposure to toxic chemicals.

U.S. EPA maintains the handbooks and periodically updates them using current literature and data available through U.S. EPA's research and other reliable sources. The handbooks are available on U.S. EPA's Web site at www.epa.gov/ncea.

One important determinant of human exposure to toxic chemicals via inhalation of contaminants in air is a person's *ventilation rate* (\dot{V}_E), the volume of air inhaled in a specified time period (e.g., liters per minute, hour, or day). In the scientific literature, \dot{V}_E is often

abbreviated \dot{V}_E (with the dot above the V indicating that the abbreviation represents ventilation “rate” rather than “volume”) and has occasionally been referred to as “breathing rate” or “inhalation rate,” among other terms. Values of \dot{V}_E s for both adults and children are given within Chapter 6 (Inhalation) of the handbooks and originate from several published studies, each having considered different approaches and target populations.

In multiroute exposure assessments, U.S. EPA recognizes that metabolism “can become the systemic organizing principle for simplifying intake/uptake dose modeling” (McCurdy, 2000). Metabolism can be quantifiably measured through energy expenditure (EE). Layton (1993) was the first to demonstrate how EE could be used to characterize inhalation exposures by estimating metabolically consistent \dot{V}_E s for different age/gender cohorts. Layton’s approach, as cited in the handbooks, calculated \dot{V}_E as the product of EE (expressed in energy units per unit time—typically on a daily basis), oxygen uptake (H ; the volume of oxygen consumed per energy unit), and ventilatory equivalent (VQ ; a unitless ratio of inhaled air volume to H). Layton (1993) used a constant value for H (equal to 0.05 L O₂/KJ or 0.21 L O₂/kcal) and VQ (equal to 27) while representing average daily EE by each of the following three approaches:

- 1) EE = average daily intake of food energy as determined from dietary survey data, adjusting for the under-reporting of foods.
- 2) EE = basal metabolic rate (BMR; energy expended per day, determined as a function of body weight) multiplied by the ratio of total daily EE to BMR that is reported in earlier publications.
- 3) EE = average EE associated with different levels of physical activity that a person experiences in an average day, as determined from time-activity survey data. Activity-specific EEs were calculated as the product of a person’s BMR, the activity’s metabolic equivalent (METS) score (i.e., a measure of the activity’s metabolic rate relative to a person’s BMR), and the duration of time spent performing the activity.

Among the data sources used by Layton (1993) in these calculations are the U.S. Department of Agriculture (USDA) 1977–78 Nationwide Food Consumption Survey, the Second National Health and Nutrition Examination Survey (NHANES), and various exposure and activity studies published primarily in the 1980s.

One limitation of Layton's approach to calculating \dot{V}_E is its dependence on ventilatory equivalent (VQ), which relies on an individual's fitness and EE levels. The VQ value of 27 used in Layton (1993) may be appropriate for adults, but not necessarily for children. In addition, the relationship between oxygen consumption and \dot{V}_E has been documented to be nonlinear (Hebestreit et al., 1998, 2000), even among equally fit individuals. These limitations introduce bias to the results. As a result, staff at U.S. EPA's National Exposure Research Laboratory (NERL) have developed a revised approach, documented in the U.S. EPA document within Appendix A, which calculates \dot{V}_E as a direct function of a person's oxygen consumption rate (VO_2). U.S. EPA has implemented the methodology in Appendix A within the inhalation modules of population-based probabilistic exposure models, including the Stochastic Human Exposure and Dose Simulation (SHEDS) model and the Air Pollution Exposure (APEX) model. The methodology features linear regression models that predict \dot{V}_E s that are normalized for body mass and account for activity level, variability within age groups, and variation both between and within individuals. This document presents metabolically derived human \dot{V}_E s that were calculated by applying this methodology to data from such sources as the 1999–2002 NHANES and U.S. EPA's Consolidated Human Activity Database (CHAD). The data were analyzed for various age categories and gender. Age categories for children were based on U.S. EPA's *Guidance on Selecting Age Groups for Monitoring and Assessing Childhood Exposures to Environmental Contaminants* (U.S. EPA, 2005). Infants under 1 year of age were grouped into one category because of sample-size limitations.

There are two other methodologies found in the literature for estimation of \dot{V}_E s. One is the doubly labeled water method for estimating EE (Brochu et al., 2006a, b), while the other uses food-energy intakes from nationwide food intake surveys to estimate EEs (Layton, 1993; Arcus-Arth and Blaisdell, 2007). Doubly labeled water is water in which both the oxygen and hydrogen atoms are replaced with nonradioactive isotopes of these elements (2H_2O and $H_2^{18}O$). The methodology is used to measure metabolic rate by measuring the disappearance rate of the isotopes deuterium (2H) and heavy oxygen-18 (^{18}O) in urine, saliva, or blood samples over time following the ingestion of predetermined doses of doubly labeled water (Brochu et al., 2006a, b). This methodology is the most accurate measurement of the total daily EEs and the stored daily

energy cost for growth, parameters necessary for the estimation of daily \dot{V}_E s. Arcus-Arth and Blaisdell (2007) used the methodology developed by Layton (1993) and updated the estimates of \dot{V}_E s by using food intake data from USDA's Continuing Survey of Food Intake by Individuals (USDA, 2000). The methodology presented in this document and the other two methodologies found in the literature all have strengths and limitations. The doubly labeled methodology has a disadvantage: it assumes a fixed H and ventilatory equivalent. In reality, these are known to vary with age and fitness level. However, the doubly labeled approach provides reliable estimates of average daily inhalation rates because direct measurements are taken for a long period of time. The methodology is not useful, however, for estimating variability in an individual's \dot{V}_E (or other parameter) over shorter time periods (i.e., \dot{V}_E s for various levels of exertion).

The food-energy consumption methodology has limitations resulting from the collection of data from a recall survey instrument. Food intake, especially for children, may be underreported. It also relies on accurate estimates of both H and ventilatory equivalents (VQ).

One advantage of the metabolically derived \dot{V}_E s is that it does not require any assumptions about VQ. The estimates derived using this methodology add to the current body of knowledge regarding \dot{V}_E s. The methodology presented in this document also has some limitations. These are described in more detailed in Section 4.1. For example, there may be biases introduced by the assumed physical intensity or exertion associated with recorded activities for the specific purpose of estimating EEs. In addition, the methodology requires reliable estimates of the BMR, for which data are limited for some age groups. The methodology also may be more appropriate for estimating activity-specific \dot{V}_E s rather than long-term daily averages.

In order to provide some validation of the metabolically derived \dot{V}_E s presented in this document, U.S. EPA conducted analyses comparing the three methodologies. Appendix D provides a summary of these analyses and additional description of how U.S. EPA's APEX model uses the methodology in Appendix A to estimate \dot{V}_E s. It also compares the estimates generated by the methodology (as applied within the APEX model) with those of two other recently reported methodologies.

2. DATA SOURCES

The approach presented in this document for calculating metabolically based \dot{V}_E for a person within a specific age and gender subpopulation uses the following information on that person:

- Body weight;
- BMR, a measure of a person's EE while at physical and mental rest (i.e., in the absence of activity requiring exertion), primarily to perform basic brain, liver, and skeletal muscle function (McCurdy, 2000);
- Typical 24-hour activity pattern (i.e., types of activities performed in a given day and the duration for which each activity was conducted); and
- METS values associated with each activity type.

After carefully identifying and evaluating various sources for these different types of information, U.S. EPA selected the data sources below for use in this effort. Each data source provides a specific type of information for an individual.

2.1. SOURCE OF BODY WEIGHT DATA: 1999–2002 NHANES

The Centers for Disease Control and Prevention's (CDC) National Center for Health Statistics operates the NHANES program of studies. NHANES is designed to assess the health and nutritional status of adults and children in the United States. Begun in the 1960s, the NHANES program originally consisted of a periodic series of surveys focusing on different population groups or health topics. Data collected within the NHANES originates from personal interviews and physical examinations.

Beginning in 1999, the NHANES became a continuous, annual survey rather than the periodic survey that it had been in the past. The survey examines a nationally representative sample of persons each year. The CDC now releases public-use data files every 2 years. Data used in this document originated from public-use data files labeled as "NHANES 1999–2000" and "NHANES 2001–2002," upon CDC's recommendation that NHANES data collected from 1999 to 2002 should be considered as originating from a single survey (CDC, 2005). A total of

21,004 individuals were represented in the combined data set, which is comprised of (CDC, 2004):

- 1999–2000: Interview sample size = 9,965; examination sample size = 9,282
- 2001–2002: Interview sample size = 11,039; examination sample size = 10,477

U.S. EPA selected the NHANES 1999–2002 database because it is the most complete and recent nationally representative source of body weight data for the U.S. population and for subcategories determined by age and gender (CDC, 2000, 2002). Reported body weights were measured by trained health professionals during an interview process using measuring equipment that was consistent from year to year. Within this database, a total of 19,022 individuals had recorded data for age, gender, and body weight. Table 2-1 presents the number of individuals according to the age and gender categories considered in this document. In addition, Tables C-1a and C-1b of Appendix C presents a summary of body weight data for the NHANES subjects represented in Table 2-1 by gender and age category.

Table 2-1. Numbers of individuals from NHANES 1999–2002 with available age, gender, and body weight data, by age and gender categories

Age Category ^a	Gender Category		
	Male	Female	Total
Birth to <1 year	419	415	834
1 year	308	245	553
2 years	261	255	516
3 to <6 years	540	543	1,083
6 to <11 years	940	894	1,834
11 to <16 years	1,337	1,451	2,788
16 to <21 years	1,241	1,182	2,423
21 to <31 years	701	1,023	1,724
31 to <41 years	728	869	1,597
41 to <51 years	753	763	1,516
51 to <61 years	627	622	1,249
61 to <71 years	678	700	1,378
71 to <81 years	496	470	966
81 years and older	255	306	561
Total	9,284	9,738	19,022

^aAn age category labeled as “x to <y years” denotes the first day of x years of age to the last day of (y – 1) years of age. “1 year” represents 12 to 23 months, and “2 years” represents 24 to 35 months.

2.2. SOURCE OF BMR CALCULATION: SCHOFIELD (1985)

As noted earlier, a person's basal metabolic rate, or BMR, is a measurement of energy required to maintain the body's normal body functions while at rest. Thus, it serves as a baseline to which the EE of specific activities can be related. BMR is a function of such attributes as body weight, height, age, and gender.

U.S. EPA has identified several sets of mathematical equations that researchers have published for calculating BMR as a function of one or more attributes of a person. Each such equation typically represented some subset of the population determined by age, gender, and ethnic origin. Among the candidate equations were those proposed by Schofield (1985), which express BMR (in megajoules¹ per day) as a linear function of body weight (in kg) based upon a person's gender and age category. Although these equations tend to be most representative of primarily Caucasian individuals descended from European regions, no other source of BMR estimates was judged to be a better representation of the general population. (Most alternative BMR prediction equations tend to be based on small sample sizes involving a narrowly-defined cohort of individuals.) Furthermore, the Schofield equations have been frequently cited in refereed publications, and they are currently coded in U.S. EPA's APEX and SHEDS models. They were used by Layton (1993) and are included in Appendix 5A of the Exposure Factors Handbook (U.S. EPA, 1997). U.S. EPA subsequently determined that the Schofield equations would continue to be used for the analyses presented in this document. Table 2-2 presents these equations.

Table 2-2. Equations from Schofield (1985) that predict BMR (MJ/day) as a function of body weight (BW, kg)

Age Category ^a	Male	Female
Birth to <3 years	$BMR = 0.249 \times BW - 0.127$	$BMR = 0.244 \times BW - 0.130$
3 to <10 years	$BMR = 0.095 \times BW + 2.110$	$BMR = 0.085 \times BW + 2.033$
10 to <18 years	$BMR = 0.074 \times BW + 2.754$	$BMR = 0.056 \times BW + 2.898$
18 to <30 years	$BMR = 0.063 \times BW + 2.896$	$BMR = 0.062 \times BW + 2.036$
30 to <60 years	$BMR = 0.048 \times BW + 3.653$	$BMR = 0.034 \times BW + 3.538$
60 years and older	$BMR = 0.049 \times BW + 2.459$	$BMR = 0.038 \times BW + 2.755$

^aAn age category labeled as "x to <y years" denotes the first day of x years of age to the last day of (y - 1) years of age.

¹A megajoule (MJ) equals 1 million joules, or, approximately, 238.846 kilocalories (kcal).

U.S. EPA recognizes that since the Schofield equations were derived, increased rates of obesity, overweight incidence, and sedentariness have been observed in some sectors of the U.S. population, especially children and adolescents (e.g., Derumeaux-Burel et al., 2004). This may impact the representativeness of BMR predictions generated by the Schofield equations for certain age groups, such as children under 4 years of age. U.S. EPA continues to reinvestigate the issue of revising BMR predictions to account for more recently published information. Any necessary revisions to the prediction process will be incorporated into the intake dose rate modeling procedures used by the APEX and SHEDS models.

2.3. SOURCE OF ACTIVITY AND METS DATA: CONSOLIDATED HUMAN ACTIVITY DATABASE (CHAD)

CHAD is the central source of information on activity patterns and METS values for individuals within various age and gender categories. Available from <http://www.epa.gov/chadnet1> and documented in U.S. EPA (2002), CHAD contains data from 12 preexisting human activity studies that were conducted within the U.S. at the city, state, and national levels. It is intended for use by exposure assessors and modelers as a source of activity data for exposure/intake dose modeling and/or statistical analysis. CHAD contains nearly 23,000 person-days of time-location-activity data representing all ages and genders and which can be used for exposure modeling purposes (McCurdy et al., 2000).

U.S. EPA's NERL has developed and maintained CHAD since 1997. CHAD incorporates various human activity databases that U.S. EPA has used over the years. Each of these databases contains information on each activity undertaken by a given study subject during a monitoring period of at least 24 hours. This activity-specific information includes the activity's ID code (taken from the list of activity codes in Appendix B that corresponded to the set of standardized activities that were applied across all studies within the database), location, duration expended, and an estimate of the metabolic cost of performing the activity. Metabolic cost is given in units of "METS" or "metabolic equivalents of work," an EE metric used by exercise physiologists and clinical nutritionists to represent activity levels. An activity's METS value represents a dimensionless ratio of its metabolic rate (EE) to a person's resting, or basal, metabolic rate.

The CHAD assigns a METS value to an activity according to the standardized ID code that it assigned to the activity (see Appendix B). However, for most activities, it does not always assign the same single point METS value to each occurrence of the same activity within the database. Instead, the CHAD assigned a statistical distribution to each activity ID code (McCurdy et al., 2000) representing the distribution of possible METS values associated with that activity. Whenever a specific activity ID code was encountered within a study respondent's data records, the CHAD generated a random value from the code's assigned distribution to serve as the METS value for that particular activity. The statistical distributions that the CHAD assigned to each activity ID code were specified in Appendix 1 of U.S. EPA (2002) and are presented in Appendix B. The distributional forms included normal, lognormal, uniform, triangular, and exponential distributions, as well as point estimates (i.e., when the same METS value was to be assigned for all occurrences). For some activity codes, the CHAD occasionally assigned a different form of the distribution to different age categories (<25 years, 25–40 years, >40 years), in order to account for different ranges of intensity levels that may occur among these age groups when performing the specified activity. Appendix B also lists lower and upper bounds for certain distributions, where the lower bound was assigned in lieu of the randomly generated METS value when the latter fell below the bound, and the upper bound was assigned whenever the randomly generated METS value fell above the bound.

For this analysis, U.S. EPA utilized the distributions that had previously been assigned to each activity code as specified in Appendix 1 of U.S. EPA (2002). No documentation was available within CHAD to justify why certain distributions were assigned to a particular activity code, why different distributions were assigned to different age categories within an activity code, or why the age categories within these distributions were defined as they were. Section 3 presents more information on the specific approach used in this document to assign METS values to activities prior to calculating \dot{V}_E .

2.3.1. The National Human Activity Pattern Survey

Many of the studies in CHAD focused their sample within a certain age range, such as children or senior citizens, and/or a single region or city. Only one study was conducted on a national scale: the U.S. EPA-sponsored National Human Activity Pattern Survey (NHAPS). Conducted from 1992 to 1994 by the University of Maryland Survey Research Center, the

NHAPS was a probability based national telephone interview survey of 9,386 respondents that collected retrospective diary information on activities performed over a 24-hour day, along with personal and exposure-related data (Klepeis et al., 2001). Participants were selected using a stratified sampling approach, with stratification corresponding to the four major U.S. census regions (Northeast, Midwest, South, West) within the 48 contiguous states (Klepeis et al., 2001). U.S. EPA adopted the method used in the NHAPS study for assigning activity codes as the common method for coding activities across all studies within the CHAD.

Based upon the NHAPS study's more general representation of the U.S. population compared to the other studies within CHAD, activity data from the NHAPS study were selected for use in characterizing activity patterns and obtaining METS values when calculating \dot{V}_E estimates for this document. Within CHAD, NHAPS data records were distinguished by the type of questionnaire that the survey provided to the study subjects. Because this discernment did not affect the recording of information on activities performed in the previous 24-hour period and on the duration spent performing each of these activities, all data records were utilized in the analyses within this document regardless of the questionnaire type used. Tables 2-3 presents a breakdown of the number of NHAPS respondents with available activity data, according to the age and gender categories considered in this document. A total of 9,196 respondents had available age and gender information, and, therefore, contributed information to this analysis. (Each of these respondents contributed 24 hours worth of activity pattern data.)

One major limitation to the use of the NHAPS study data in this document was the lack of body-weight measurements within the CHAD data records for the study respondents. When an NHAPS respondent's data records are accessed interactively within the CHAD, the database assigns a simulated body-weight measurement to that respondent by sampling randomly from a lognormal distribution that is specific to the respondent's age and gender. (Details on the lognormal distributions are not provided within U.S. EPA, 2002.) However, these simulated body-weight measurements could not be downloaded with the other study data for use in this document. Therefore, the NHAPS data were used only for characterizing the activity patterns of an individual within a given age and gender category, while the CHAD also provided the approach for assigning METS values to specific activities.

Table 2-3. Numbers of individuals from the NHAPS study by age and gender categories

Age Category ^a	Gender Category		
	Male	Female	Total
Birth to <1 year	53	30	83
1 year	67	64	131
2 years	63	61	124
3 to <6 years	184	169	353
6 to <11 years	261	225	486
11 to <16 years	234	239	473
16 to <21 years	234	227	461
21 to <31 years	755	748	1,503
31 to <41 years	737	848	1,585
41 to <51 years	588	736	1,324
51 to <61 years	453	548	1,001
61 to <71 years	354	536	890
71 to <81 years	199	380	579
81 years and older	59	144	203
Total	4,241	4,955	9,196

^aAn age category labeled as “ x to $<y$ years” denotes the first day of x years of age to the last day of $(y - 1)$ years of age. “1 year” represents 12 to 23 months, and “2 years” represents 24 to 35 months.

Although the NHAPS study features a probabilistic sampling design, it does not select respondents or their 24-hour monitoring periods purely randomly. For example, weekend days were over sampled, while, in selected households having children, a child had a higher probability for selection than an adult. While the NHAPS study team assigned sample weights to respondents to account for the sampling design, these sample weights are not available within CHAD, and, therefore, are not utilized in the analyses presented in this report. Also, certain reviewers noted that the telephone/retrospective approach to collect activity data in the NHAPS, which involved recounting of activities done in the previous 24 hours, can, occasionally, result in less accurate or less complete information than if a prospective/real-time diary was kept by the study subjects. However, no comparable data set could be identified that both recorded activity data in real time and would be nationally representative of the U.S. population.

3. APPROACH

The document in Appendix A describes an approach for estimating \dot{V}_E from VO_2 using a series of regression-based equations derived from data collected from 25 years of clinical studies by Dr. William C. Adams of the University of California at Davis (Adams, 1993; Adams et al., 1995). The multistep approach presented in this section applies these equations to the data sources cited within Section 2 to estimate \dot{V}_E . An overview of the steps involved in this approach is as follows:

1. Categorize individuals in the NHANES 1999–2002 and NHAPS data sets by age and gender.
2. Calculate BMR for NHANES individuals as a function of body weight.
3. Obtain a simulated 24-hour activity pattern for each NHANES individual.
4. Assign a METS value to each activity represented in an NHANES individual's simulated 24-hour activity pattern.
5. Calculate EE and VO_2 for each activity within an NHANES individual's simulated 24-hour activity pattern.
6. Calculate activity-specific \dot{V}_E values for an NHANES individual using the equations derived in the U.S. EPA document (see Appendix A) that express \dot{V}_E (adjusted for body weight) as a function of VO_2 (adjusted for body weight), age, and gender.
7. Calculate average daily \dot{V}_E , as well as average \dot{V}_E for activities sharing a similar intensity level, for each NHANES individual.
8. Summarize average \dot{V}_E values across individuals for each age and gender category.

Each step is further discussed in the subsequent sections of this document.

3.1. STEP 1: GROUP NHANES AND NHAPS PARTICIPANTS BY AGE AND GENDER CATEGORIES

Once the NHANES and NHAPS data were obtained for this analysis, the individuals represented in each data set were grouped into age and gender categories using information stored within the data records. Adults from 21 to 80 years were divided into six groups, each of size 10 years (21-30 years, 31-40 years, etc.), while adults above 80 years were placed in a single group. Children (<21 years) were divided into seven age categories according to groupings given in U.S. EPA (2005) with the following exception: children less than 1 year old were placed into a single group rather than further divided by age. If these children were further segregated, the resulting age-related groups would have had insufficient sample sizes for the analyses presented in this document.

Tables 2-1 and 2-3, in Section 2, list the age and gender categories used in this analysis, along with the numbers of individuals within the NHANES and NHAPS data sets, respectively, that were grouped into each category. A total of 19,022 NHANES participants and 9,196 NHAPS participants were grouped into these categories, corresponding to those individuals having sufficient data to allow the grouping and to contribute to this analysis.

3.2. STEP 2: CALCULATE BMR ESTIMATES FOR NHANES PARTICIPANTS

As noted in Section 2, body-weight data were available for individuals in the NHANES data set (originating from data collected during the survey's medical examinations) but not for NHAPS participants; therefore, BMR estimates could be calculated only for the 19,022 NHANES individuals. The Schofield equations given in Table 2-2 of Section 2 were used to calculate these estimates as a function of age, gender, and body weight. However, the approach in Appendix A assumes that BMR is expressed in kcal/min, while the Schofield equations calculate BMR in MJ/day. Given that 1 MJ equals 238.846 kcal, BMR was converted from MJ/day to kcal/min as follows: $BMR (kcal/min) = 0.16587 \times [BMR (MJ/day)]$.

3.3. STEP 3: GENERATE A SIMULATED 24-HOUR ACTIVITY PATTERN FOR EACH NHANES PARTICIPANT

Table 2-3 of Section 2 gives the number of NHAPS participants within each age/gender category. Each of these participants had activity pattern data available for a single 24-hour

monitoring period. For a given age/gender category, let N correspond to the number of NHAPS participants in that category, as given in Table 2-3. Each participant in this category was then assigned a unique group ID number from 1 to N .

For each of the 19,022 individuals in the NHANES data set, the following procedure was performed to generate a simulated 24-hour activity pattern for that individual:

- The individual's age/gender category was noted.
- Twenty (20) random integers were generated, with replacement, from the set of integers ranging from 1 to N (i.e., N = number of NHAPS participants within the individual's age/gender category). The number of random integers to select (20) was arbitrarily determined.
- For each random integer that was generated, data on the recorded 24-hour activity pattern (activity ID codes and the duration of time spent performing each activity) were obtained for the NHAPS participant whose group ID number within the given age/gender category matched the random integer. This resulted in assigning a "simulated" set of activity data to the NHANES individual that represented a total of $20 \times 24 = 480$ hours. (Because an integer could occur multiple times within the generated set of 20 random integers, a given set of 24-hour activity pattern data could likewise be represented multiple times within the simulated set of activity data.)
- The different activity ID codes were identified in this simulated set, and for each code, the duration of time (in minutes) spent performing that activity was totaled across all records within this set. This total duration was then divided by 28,800 (i.e., the number of minutes in 480 hours) to estimate the proportion of this total time that is represented by the given activity. The proportions associated with each activity were then each multiplied by 24 to yield a simulated number of hours that the given NHANES individual was deemed to perform the activity within a 24-hour period.

Note that activities could not be assigned to NHANES participants based on prior knowledge of their preferences and lifestyles because this information was unavailable. Furthermore, because no body weight data were available on NHAPS participants, it is not possible to account for body weight in assigning an activity pattern to NHANES participants.

3.4. STEP 4: GENERATE A METS VALUE FOR EACH ACTIVITY WITHIN THE SIMULATED 24-HOUR ACTIVITY PATTERN FOR EACH NHANES PARTICIPANT

Once a simulated 24-hour activity pattern was assigned to a given NHANES individual, it was necessary to assign a METS value to each activity ID code represented within that activity pattern. METS values were assigned following the same approach used in the CHAD. As first noted in Section 2.3, the CHAD has assigned statistical distributions to each activity ID code. Appendix B lists these statistical distributions. While most activity ID codes were assigned a single distribution, a few codes were assigned different distributions for different age ranges, apparently to account for different ranges of intensity levels that may occur among different age groups performing the same type of activity.

As is done in the CHAD, for each activity ID code encountered within the simulated 24-hour activity pattern for an NHANES individual, a METS value was assigned to that activity by randomly sampling from the statistical distribution that CHAD has assigned to that code (and, when necessary, to the age range in which the individual falls). The procedure developed to generate random numbers from each of the distribution types represented within Appendix B used random number generator functions available within the SAS[®] System (SAS, 2005). These functions yield the following:

- *RANEXP*, a random number from a standard exponential distribution (scale parameter = 1).
- *RANNOR*, a random number from a standard normal distribution (mean = 0, standard deviation = 1).
- *RANTRI*, a random number from a triangular distribution on the interval (0, 1) with parameter *H*, a number between 0 and 1 which represents the distribution's modal value.
- *RANUNI*, a random number from a uniform distribution on the interval (0, 1).

The random number generation procedure depended not only on the particular distributional form (e.g., uniform, normal, lognormal, exponential, triangular), but, also, on specific parameters associated with the distribution, such as the mean (*mean*), standard deviation (*std*), minimum (*min*), and maximum (*max*), which are specified along with the distributions in Appendix B. The *exp* denotes the exponentiation function, *log* denotes the natural logarithmic function, and *sqrt*

denotes the square root function. Then random numbers for the distributions in Appendix B were generated as follows:

- Exponential distribution: $METS = min + std \times RANEXP$
- Lognormal distribution: $METS = exp \{ \log [mean^2 / \sqrt{mean^2 + std^2}] \} + \sqrt{\log [1 + (std/mean)^2]} \times RANNOR$
- Normal distribution: $METS = mean + std \times RANNOR$
- Triangular distribution: The generated METS value depends on the value of the mode of the triangular distribution, which equals $3 \times mean - min - max$.
 - If $mode = min$, then $METS = max - \sqrt{(1 - RANUNI) \times (max - min) \times (max - mode)}$
 - If $mode = max$, then $METS = min + \sqrt{RANUNI \times (max - min) \times (mode - min)}$
 - If $min < mode < max$, then $METS = min + (max - min) \times RANTRI$, where the value of H used to determine $RANTRI$ equals $(mode - min)/(max - min)$.
- Uniform distribution: $METS = min + (max - min) \times RANUNI$.

Whenever an activity ID code's distribution was specified as a "point estimate," the distribution consisted of a single value that occurred with 100% probability. Therefore, for such an activity ID code, the METS value was always assigned to equal this single value.

The distributions for some activity ID codes were accompanied by a specified lower and upper bound (see Appendix B). In these situations, the lower bound was assigned in lieu of the randomly generated METS value when the latter fell below the bound, and the upper bound was assigned whenever the randomly-generated METS value fell above the bound.

In November 2003, the CHAD incorporated a new feature which identified "maximum possible METS values" that could be assigned to children aged 16 years and younger when performing an activity that is 5 minutes or more in duration. This feature was implemented due to U.S. EPA's finding that a child does not experience a METS value above a certain threshold (McCurdy and Graham, 2004). Table 3-1 presents these maximum possible values by age and gender. When METS values were generated from the statistical distributions specified in

Appendix B, those values exceeding the maximum specified in Table 3-1 were replaced by the maximum.

Table 3-1. Maximum possible METS values assigned to children, by age and gender

Age (years)	Gender	
	Males	Females
6 and younger	7.2	6.4
7	7.7	6.8
8	8.2	7.3
9	8.7	7.7
10	9.2	8.2
11	9.8	8.7
12	10.5	9.3
13	11.1	10.0
14	11.8	10.6
15	12.6	11.3
16	13.4	12.2

Source: [http://oaspub.epa.gov/chad/recent_additions\\$.startup](http://oaspub.epa.gov/chad/recent_additions$.startup)

3.5. STEP 5: CALCULATE ENERGY EXPENDITURE AND VO_2 FOR EACH ACTIVITY WITHIN AN INDIVIDUAL'S SIMULATED 24-HOUR ACTIVITY PATTERN

Once the METS values were generated, EE (expressed in kcal/min) associated with a given activity was calculated by multiplying the activity's assigned METS value by the BMR value assigned to the individual within Step 2: $EE = BMR \times METS$. This calculation was done for each activity ID code encountered within an individual's simulated 24-hour activity pattern.

Once the set of activity-specific EE values were obtained for a given NHANES individual, activity-specific values of the VO_2 (expressed in L O_2 /min) were calculated from these values according to the approach given in the document in Appendix A. VO_2 was calculated as the product of EE (kcal/min) and H , the volume of oxygen consumed per unit of energy (L O_2 /kcal): $VO_2 = EE \times H$.

In each application of this equation, the value of H is obtained by randomly sampling from the uniform distribution over the interval (0.20, 0.22) for males and (0.19, 0.21) for females. (These two distributions were obtained from Table A-1 of Appendix A and differ slightly from the distribution given in McCurdy, 2000. For a given gender, the specified uniform

distribution did not differ according to age.) VO_2 values were normalized by body weight by dividing VO_2 by the individual's body weight (in kg).

3.6. STEP 6: CALCULATE VENTILATION RATE FOR EACH ACTIVITY WITHIN THE SIMULATED 24-HOUR ACTIVITY PATTERN FOR EACH NHANES PARTICIPANT

Within this step, the *multiple linear regression model* presented in Section 2 of Appendix A was applied to data on each activity within the simulated 24-hour activity pattern of an NHANES participant in order to predict that person's \dot{V}_E (expressed in L/min), adjusted for body weight, when performing the given activity. For each activity within an individual's activity pattern, the model predicted \dot{V}_E as a function of VO_2 estimated within Step 5 (also after adjusting for body weight), age, and gender. The multiple linear regression model took the following form: $\log(\dot{V}_E/BW) = b_0 + b_1 \times \log(VO_2/BW) + b_2 \times \log(age) + b_3 \times gender + \varepsilon$ where "log" indicates the natural logarithmic transformation, BW corresponds to the individual's body weight (kg), age denotes the individual's age (in years), and $gender$ equals -1 for males and $+1$ for females. The term represents random deviation between the actual and predicted value of the left-hand side of the equation for individuals having the same age, gender, and (VO_2/BW) value and is assumed to originate from a normal distribution with a mean of 0 and a standard deviation of σ . Estimated values of the intercept and slope parameters (b_0 , b_1 , b_2 , and b_3) σ and were provided for specified age ranges and are given in Table 3-2. These age ranges were determined based on prior usage (such as in Johnson, 2002) and on what would result in a best fit of the regression model, as noted in Appendix A.

Table 3-2. Estimated values, by age range, of the parameters within the multiple linear regression model for predicting body-weight adjusted ventilation rate (\dot{V}_E/BW ; L/min/kg)

Age	b_0	b_1	b_2	b_3	σ
<20 years	4.4329	1.0864	-0.2829	0.0513	0.1444
20-33 years	3.5718	1.1702	0.1138	0.0450	0.1741
34-60 years	3.1876	1.1224	0.1762	0.0415	0.1727
>60 years	2.4487	1.0437	0.2681	-0.0298	0.1277

Source: Table A-3 of Appendix A.

For each activity within an individual's simulated 24-hour activity pattern, the predicted values of \dot{V}_E/BW were determined as follows:

- The following information was entered into the regression equation: the ratio of the individual's calculated VO_2 for that activity to the individual's body weight, the individual's age and gender codes, and estimates of the intercept and slope parameter (b_0 , b_1 , b_2 , and b_3 , from Table 3-2) that are relevant to the individual's age.
- For the model's random error term, a random number was generated from a normal distribution with mean zero and standard deviation equal to the estimate given in Table 3-2 for σ . This random number was then substituted for the error term in the regression equation.
- The equation was then calculated, and the result was exponentiated.

The predicted value of \dot{V}_E that is unadjusted for body weight was determined by multiplying this result by the individual's body weight.

In developing this step, U.S. EPA had also considered an alternate form of the regression model for predicting \dot{V}_E/BW , which was also presented in Appendix A. In this alternate model, called a *mixed-effects regression model*, the random error term of the multiple linear regression model is divided into two additive components, ϵ_b and ϵ_w , representing between-person and within-person variability, respectively: $\log(\dot{V}_E/BW) = b_0 + b_1 \times \log(VO_2/BW) + b_2 \times \log(\text{age}) + b_3 \times \text{gender} + (\epsilon_b + \epsilon_w)$, where all other terms are as defined in the multiple linear regression model. Both ϵ_b and ϵ_w are assumed to originate from normal distributions with mean 0, but with different standard deviations σ_b and σ_w , respectively. Estimated values of the intercept and slope parameters (b_0 , b_1 , b_2 , and b_3), σ_b , and σ_w are given in Table 3-3 for the same age ranges given in Table 3-2. Note that because the two models differ in their random component, their parameter estimates differ as well.

Appendix A provides more details on the derivation of the multiple linear-regression model and the mixed-effects regression model, along with their parameter estimates. Upon observing how \dot{V}_E estimates compare between the two methods, which is discussed in Section 4, the multiple linear-regression model was used as the basis for the \dot{V}_E estimates presented in this document.

Table 3-3. Estimated values, by age range, of the parameters within the mixed effects regression model for predicting body-weight adjusted ventilation rate (\dot{V}_E/BW ; L/min-kg)

Age	B_0	b_1	b_2	b_3	σ_b	σ_w
<20 years	4.3675	1.0751	-0.2714	0.0479	0.0955	0.1117
20–33 years	3.7603	1.2491	0.1416	0.0533	0.1217	0.1296
34–60 years	3.2440	1.1464	0.1856	0.0380	0.1260	0.1152
>60 years	2.5828	1.0840	0.2766	-0.0208	0.1064	0.0676

Source: Table A-3 of Appendix A.

3.7. STEP 7: CALCULATE AVERAGE VENTILATION RATE FOR TIME SPENT PERFORMING ACTIVITIES WITHIN SPECIFIED METS CATEGORIES, AS WELL AS 24-HOUR AVERAGE VENTILATION RATE, FOR EACH NHANES PARTICIPANT

Once values of \dot{V}_E and \dot{V}_E/BW were predicted for each reported activity ID code within an individual’s simulated 24-hour activity pattern (Step 6), an average daily \dot{V}_E was calculated for the individual, both across the entire 24-hour activity pattern, as well as within specified activity categories that were determined by level of intensity (based on assigned METS values). Within the individual’s simulated 24-hour activity pattern, each activity was classified into one of four activity categories that were, in turn, associated with intensity level:

- Sedentary/Passive Activities: Activities with METS values no higher than 1.5.
- Light Intensity Activities: Activities with METS values exceeding 1.5, but no higher than 3.0.
- Moderate Intensity Activities: Activities with METS values exceeding 3.0, but no higher than 6.0.
- High Intensity Activities: Activities with METS values exceeding 6.0.

(These categories were defined based on general information in the scientific literature on how researchers have grouped activities according to intensity level.) Within an activity category, let A represent the number of activities within the individual’s simulated 24-hour activity pattern

that fall within the category, and let T equal the total duration of time (in minutes) that the individual spent performing these A activities. Let $V_{E,i}$ represent the individual's \dot{V}_E calculated in Step 6 for the i^{th} activity within this activity category, and let T_i correspond to the duration of time spent by the individual performing this activity ($i = 1, \dots, A$). Then the individual's average daily \dot{V}_E for that METS activity group was calculated as a weighted average of the activity-specific \dot{V}_E values, with weights corresponding to time spent performing the activities:

$$\dot{V}_E = \frac{\sum_{i=1}^A (T_i \times V_{E,i})}{T}$$

For each NHANES individual, this average \dot{V}_E statistic was calculated within each of the four activity categories, as well as across all activities within the individual's simulated 24-hour activity pattern. The latter average was calculated using the same formula as above, with A equaling the total number of activities within the 24-hour activity pattern, and T equaling 1,440 minutes (i.e., the total number of minutes in a 24-hour period). These average daily \dot{V}_E values were adjusted for body weight by dividing by the individual's body weight.

3.8. STEP 8: CALCULATE SUMMARY TABLES ACROSS INDIVIDUALS

For each age and gender category noted in Tables 2-1 and 2-3, individual-specific average \dot{V}_E values from Step 7 were summarized across individuals for each of the four METS activity categories, for a 24-hour period, and for sleeping and napping activities only (i.e., activity code 14500). These summaries corresponded to weighted descriptive statistics, with the weights corresponding to the individuals' 4-year sampling weights stored within the NHANES 1999–2002 database. The descriptive statistics, which were calculated using the UNIVARIATE procedure within the SAS[®] System, included the mean, maximum, and selected percentiles of the observed distribution among the 19,022 NHANES participants.

4. RESULTS

This section presents tables that summarize the results of the eight-step statistical technique described in Section 3, which predict ventilatory rate from simulated 24-hour activity data assigned to individuals represented within the NHANES 1999–2002 data base (Section 2). The results in this section were generated using Version 9 (Release 9.1.3) of the SAS[®] System (SAS, 2005). Appendix C provides supplemental summary tables that provide more detailed information that accompanies the results presented in this section.

The multiple linear regression model in Section 3.6 was used to predict ventilatory rate as a function of VO_2 , age, and gender for each activity assigned to each individual in the NHANES data set. Section 3.6 also cites a mixed effects model which differed from the multiple linear regression model in how its random component was specified (i.e., the multiple linear regression model included a single random error term, while the mixed effects model separated random error into two additive terms that represented between-individual and within-individual variability). The extent to which predictions differed between the two types of models was minimal; the median percentage change in the mixed effect regression model prediction relative to the multiple linear regression model prediction was a two percentage point decline. The multiple linear regression model predicted higher ventilatory rate estimates 53% of the time compared to the mixed effect regression model, and this percentage did not deviate much between the two genders or among different METS categories. Because no model tended to consistently produce higher predictions compared to the other, the choice of models was not expected to impact the types of summaries presented in this section. (It should be noted, however, that if the prediction process did not incorporate a realization of the random error term(s), then the multiple linear regression model led to higher ventilatory rate predictions compared to the mixed effect regression model more frequently—about 62% of the time.)

Descriptive statistics presented in tables within this section and Appendix C include the observed mean and selected percentiles of the analyzed data. These statistics were selected to characterize the central tendency and the general range of the predicted data distribution. While no parametric distributional assumptions were placed on the observed data distributions before these statistics were calculated, the 4-year sampling weights assigned to the individuals within

NHANES 1999–2002 were used to weight each individual’s data values in the calculations of these statistics.

Table C-1 in Appendix C contains descriptive statistics on body weight and BMR for the NHANES individuals by gender and age category. This table serves to summarize the reported body weights of the individuals represented in these analyses, as well as the outcome of the BMR calculations (using the Schofield equations and conversion to kcal/min), both of which enter into calculation of EE, VO_2 , and \dot{V}_E . Sample sizes within each age/gender category were provided in Table 2-1 of Section 2.

Tables 4-1a and 4-1b summarize daily average \dot{V}_E , both adjusted and unadjusted for body weight, by age category for males and females, respectively. The daily average \dot{V}_E s entering into these summaries, in L/min, were calculated in Step 7 (Section 3.7). The summaries represent an average rate taken over a 24-hour period (and, therefore, its typical activity pattern) among individuals in the specified category. Table C-2, in Appendix C, presents the same information, but expressed in m^3/day , as is currently done in the *Exposure Factors Handbook*.

As noted in Section 3.7, average daily \dot{V}_E was also calculated for each of four groups of activities defined according to specified ranges of METS values representing sedentary/passive activity, light intensity, middle intensity, and high intensity activities. In addition, average \dot{V}_E was calculated for the period of time when an individual is sleeping or napping. This activity occurs more than any other and represents the lowest intensity activity. Thus, while sleeping and napping are included within the sedentary/passive activity category for this data analysis, it is also treated as a separate activity in the calculations. Table 4-2a (for males) and Table 4-2b (for females) summarize average \dot{V}_E , both adjusted and unadjusted for body weight, within each activity category by gender and age category. These results are presented in L/min, representing an average rate while performing the activity.

Tables 4-2a and 4-2b also summarize the number of NHANES participants whose simulated 24-hour activity pattern included activities falling within the specified category, as well as the average number of hours per day (across individuals) that individuals spent performing these activities within their simulated activity patterns.

Table 4-1a. Descriptive statistics for daily average ventilation rate (L/min) in males, by age category

Age Category	Daily Average Ventilation Rate, Unadjusted for Body Weight (\dot{V}_E ; L/min)									Daily Average Ventilation Rate, Adjusted for Body Weight (\dot{V}_E/BW : L/min-kg)								
	Mean	Percentiles							Maximum	Mean	Percentiles							Maximum
		5 th	10 th	25 th	50 th	75 th	90 th	95 th			5 th	10 th	25 th	50 th	75 th	90 th	95 th	
Birth to <1 year	6.08	3.32	3.96	4.97	6.04	7.24	8.28	8.81	11.84	0.76	0.63	0.65	0.70	0.75	0.81	0.87	0.90	1.03
1 year	9.37	6.76	7.23	8.09	9.11	10.43	11.82	12.43	16.83	0.82	0.67	0.71	0.76	0.81	0.88	0.95	1.03	1.20
2 years	9.19	6.56	7.09	7.94	9.16	10.07	11.30	12.30	19.56	0.66	0.54	0.57	0.61	0.65	0.70	0.76	0.78	0.94
3 to <6 years	8.78	7.24	7.55	7.91	8.74	9.47	10.16	10.70	13.56	0.49	0.36	0.39	0.43	0.48	0.54	0.61	0.64	0.75
6 to <11 years	9.32	7.00	7.42	8.15	9.09	10.23	11.50	12.31	17.34	0.31	0.22	0.24	0.26	0.30	0.35	0.38	0.40	0.56
11 to <16 years	10.64	7.92	8.41	9.22	10.27	11.68	13.57	14.73	19.82	0.20	0.14	0.15	0.17	0.19	0.22	0.25	0.27	0.35
16 to <21 years	11.95	8.75	9.31	10.06	11.55	13.31	15.23	16.23	27.23	0.16	0.12	0.13	0.14	0.16	0.18	0.19	0.21	0.27
21 to <31 years	13.07	8.81	9.42	10.76	12.62	14.75	17.06	18.84	30.15	0.16	0.11	0.12	0.13	0.16	0.18	0.21	0.22	0.36
31 to <41 years	14.09	9.72	10.39	11.78	13.77	15.98	18.59	20.07	28.28	0.17	0.11	0.12	0.14	0.16	0.19	0.22	0.24	0.32
41 to <51 years	14.54	10.18	10.79	12.15	14.30	16.59	18.55	19.70	31.93	0.17	0.12	0.12	0.14	0.16	0.19	0.22	0.23	0.32
51 to <61 years	14.52	10.41	11.16	12.22	14.17	16.08	18.76	20.20	26.51	0.17	0.11	0.12	0.14	0.17	0.19	0.21	0.23	0.30
61 to <71 years	12.46	9.66	10.07	11.03	12.22	13.57	15.12	16.32	19.51	0.14	0.12	0.12	0.13	0.14	0.15	0.17	0.18	0.22
71 to <81 years	11.35	9.10	9.45	10.18	11.27	12.20	13.49	14.18	17.03	0.14	0.12	0.12	0.13	0.14	0.15	0.16	0.17	0.22
81 years and older	10.52	8.30	8.73	9.60	10.35	11.33	12.51	12.98	15.72	0.14	0.12	0.12	0.13	0.14	0.15	0.16	0.17	0.19

Individual daily averages are weighted by their 4-year sampling weights as assigned within NHANES 1999–2002 when calculating the statistics in this table. Ventilation rate was estimated using the multiple linear regression model in Section 3.6.

Table 4-1b. Descriptive statistics for daily average ventilation rate (L/min) in females, by age category

Age Category	Daily Average Ventilation Rate, Unadjusted for Body Weight (\dot{V}_E ; L/min)									Daily Average Ventilation Rate, Adjusted for Body Weight (\dot{V}_E/BW : L/min-kg)								
	Mean	Percentiles							Maximum	Mean	Percentiles							Maximum
		5 th	10 th	25 th	50 th	75 th	90 th	95 th			5 th	10 th	25 th	50 th	75 th	90 th	95 th	
Birth to <1 year	5.92	3.36	3.81	4.75	5.84	6.79	8.09	8.79	18.23	0.79	0.63	0.67	0.72	0.78	0.86	0.92	0.96	1.11
1 year	9.24	6.31	7.03	7.81	9.05	10.17	12.12	12.93	17.20	0.83	0.68	0.70	0.77	0.82	0.90	0.98	1.02	1.20
2 years	8.85	6.19	6.99	7.90	8.75	9.69	10.82	11.36	15.98	0.66	0.57	0.58	0.62	0.66	0.70	0.74	0.77	0.86
3 to <6 years	8.45	6.86	7.21	7.78	8.35	9.04	9.74	10.37	13.71	0.48	0.33	0.37	0.41	0.48	0.53	0.61	0.64	0.77
6 to <11 years	8.62	6.94	7.19	7.65	8.30	9.32	10.51	11.35	14.46	0.30	0.19	0.21	0.25	0.30	0.34	0.38	0.40	0.52
11 to <16 years	9.33	7.27	7.72	8.36	9.08	10.10	11.29	12.09	18.46	0.17	0.13	0.14	0.15	0.17	0.19	0.22	0.24	0.33
16 to <21 years	9.44	6.85	7.37	8.18	9.17	10.43	11.89	12.70	20.91	0.15	0.11	0.12	0.13	0.14	0.16	0.19	0.20	0.25
21 to <31 years	10.12	7.05	7.41	8.29	9.79	11.54	13.42	14.68	20.99	0.14	0.10	0.11	0.12	0.14	0.16	0.18	0.19	0.28
31 to <41 years	10.40	7.69	8.20	9.04	10.20	11.33	12.85	14.20	19.64	0.14	0.10	0.11	0.12	0.14	0.16	0.19	0.21	0.30
41 to <51 years	11.25	8.41	8.73	9.83	11.03	12.47	13.83	14.82	24.92	0.15	0.10	0.11	0.13	0.15	0.17	0.20	0.21	0.29
51 to <61 years	11.24	8.56	9.00	9.77	11.04	12.36	13.84	14.73	17.85	0.15	0.11	0.11	0.13	0.15	0.17	0.19	0.21	0.28
61 to <71 years	9.02	7.22	7.48	8.18	8.97	9.66	10.69	11.21	14.12	0.12	0.10	0.10	0.11	0.12	0.13	0.15	0.16	0.19
71 to <81 years	8.36	6.87	7.08	7.56	8.21	9.00	9.80	10.55	12.29	0.12	0.10	0.10	0.11	0.12	0.13	0.15	0.16	0.23
81 years and older	7.74	6.38	6.57	7.04	7.65	8.24	8.92	9.68	11.76	0.12	0.10	0.10	0.11	0.12	0.14	0.15	0.15	0.20

Individual daily averages are weighted by their 4-year sampling weights as assigned within NHANES 1999–2002 when calculating the statistics in this table. \dot{V}_E was estimated using the multiple linear regression model in Section 3.6.

Table 4-2a. Average time spent per day performing activities within specified intensity categories, and average ventilation rates associated with these activity categories, for males according to age category

Age Category	# NHANES Participants Reporting Activity	Average Duration (hr/day) Spent at Activity	Ventilation Rate During this Activity ^a	
			Unadjusted for Body Weight (L/min)	Adjusted for Body Weight (L/min-kg)
Sleep or Nap (Activity ID = 14500)				
Birth to <1 year	419	13.5	3.08	0.38
1 year	308	12.6	4.50	0.40
2 years	261	12.1	4.61	0.33
3 to <6 years	540	11.2	4.36	0.24
6 to <11 years	940	10.2	4.61	0.15
11 to <16 years	1,337	9.4	5.26	0.10
16 to <21 years	1,241	8.7	5.31	0.07
21 to <31 years	701	8.4	4.73	0.06
31 to <41 years	728	8.1	5.16	0.06
41 to <51 years	753	7.9	5.65	0.07
51 to <61 years	627	8.0	5.78	0.07
61 to <71 years	678	8.3	5.98	0.07
71 to <81 years	496	8.5	6.07	0.07
81 years and older	255	9.2	5.97	0.08
Sedentary & Passive Activities (METs ≤ 1.5—Includes Sleep or Nap)				
Birth to <1 year	419	15.0	3.18	0.40
1 year	308	14.3	4.62	0.41
2 years	261	14.6	4.79	0.34
3 to <6 years	540	14.1	4.58	0.25
6 to <11 years	940	13.5	4.87	0.16
11 to <16 years	1,337	13.8	5.64	0.10
16 to <21 years	1,241	13.2	5.76	0.08
21 to <31 years	701	12.4	5.11	0.06
31 to <41 years	728	12.3	5.57	0.07
41 to <51 years	753	12.3	6.11	0.07
51 to <61 years	627	13.1	6.27	0.07
61 to <71 years	678	14.5	6.54	0.08
71 to <81 years	496	15.9	6.65	0.08
81 years and older	255	16.6	6.44	0.09

Table 4-2a. Average time spent per day performing activities within specified intensity categories, and average ventilation rates associated with these activity categories, for males according to age category (continued)

Age Category	# NHANES Participants Reporting Activity	Average Duration (hr/day) Spent at Activity	Ventilation Rate During this Activity ^a	
			Unadjusted for Body Weight (L/min)	Adjusted for Body Weight (L/min-kg)
Light-Intensity Activities (1.5 < METS ≤ 3.0)				
Birth to <1 year	419	5.3	7.94	0.99
1 year	308	5.5	11.56	1.02
2 years	261	5.5	11.67	0.84
3 to <6 years	540	6.6	11.36	0.63
6 to <11 years	940	7.6	11.64	0.38
11 to <16 years	1,337	7.5	13.22	0.25
16 to <21 years	1,241	7.1	13.41	0.18
21 to <31 years	701	6.1	12.97	0.16
31 to <41 years	728	5.7	13.64	0.16
41 to <51 years	753	6.1	14.38	0.17
51 to <61 years	627	5.6	14.56	0.17
61 to <71 years	678	5.5	14.12	0.16
71 to <81 years	496	5.0	13.87	0.17
81 years and older	255	4.9	13.76	0.18
Moderate-Intensity Activities (3.0 < METS ≤ 6.0)				
Birth to <1 year	419	3.7	14.49	1.80
1 year	308	4.0	21.35	1.88
2 years	261	3.8	21.54	1.55
3 to <6 years	540	3.2	21.03	1.17
6 to <11 years	940	2.7	22.28	0.74
11 to <16 years	1,337	2.3	26.40	0.49
16 to <21 years	1,241	3.3	29.02	0.39
21 to <31 years	701	5.2	29.19	0.36
31 to <41 years	728	5.7	30.30	0.36
41 to <51 years	753	5.4	31.58	0.37
51 to <61 years	627	5.0	32.71	0.38
61 to <71 years	678	3.7	29.76	0.34
71 to <81 years	496	2.9	29.29	0.36
81 years and older	255	2.3	28.53	0.38

Table 4-2a. Average time spent per day performing activities within specified intensity categories, and average ventilation rates associated with these activity categories, for males according to age category (continued)

Age Category	# NHANES Participants Reporting Activity	Average Duration (hr/day) Spent at Activity	Ventilation Rate During this Activity ^a	
			Unadjusted for Body Weight (L/min)	Adjusted for Body Weight (L/min-kg)
High-Intensity Activities (METS > 6.0)				
Birth to <1 year	183	0.2	27.47	3.48
1 year	164	0.3	40.25	3.52
2 years	162	0.1	40.45	2.89
3 to <6 years	263	0.3	39.04	2.17
6 to <11 years	637	0.3	43.62	1.41
11 to <16 years	1,111	0.4	50.82	0.95
16 to <21 years	968	0.4	53.17	0.71
21 to <31 years	546	0.3	53.91	0.66
31 to <41 years	567	0.4	54.27	0.64
41 to <51 years	487	0.3	57.31	0.66
51 to <61 years	452	0.4	58.42	0.68
61 to <71 years	490	0.4	54.13	0.62
71 to <81 years	343	0.4	52.46	0.65
81 years and older	168	0.3	53.31	0.72

^aAn individual's \dot{V}_E for the given activity category equals the weighted average of the individual's activity-specific \dot{V}_E s for activities falling within the category, estimated using the multiple linear regression model in Section 3.6, with weights corresponding to the number of minutes spent performing the activity. Numbers in these two columns represent averages, calculated across individuals in the specified age category, of these weighted averages. These are weighted averages, with the weights corresponding to the 4-year sampling weights assigned within NHANES 1999–2002.

Table 4-2b. Average time spent per day performing activities within specified intensity categories, and average ventilation rates associated with these activity categories, for females according to age category

Age Category	# NHANES Participants Reporting Activity	Average Duration (hr/day) Spent at Activity	Ventilation Rate During this Activity ^a	
			Unadjusted for Body Weight (L/min)	Adjusted for Body Weight (L/min-kg)
Sleep or Nap (Activity ID = 14500)				
Birth to <1 year	415	13.0	2.92	0.39
1 year	245	12.6	4.59	0.41
2 years	255	12.1	4.56	0.34
3 to <6 years	543	11.1	4.18	0.24
6 to <11 years	894	10.3	4.36	0.15
11 to <16 years	1,451	9.6	4.81	0.09
16 to <21 years	1,182	9.1	4.40	0.07
21 to <31 years	1,023	8.6	3.89	0.06
31 to <41 years	869	8.3	4.00	0.06
41 to <51 years	763	8.3	4.40	0.06
51 to <61 years	622	8.1	4.56	0.06
61 to <71 years	700	8.4	4.47	0.06
71 to <81 years	470	8.6	4.52	0.07
81 years and older	306	9.1	4.49	0.07
Sedentary & Passive Activities (METs ≤ 1.5—Includes Sleep or Nap)				
Birth to <1 year	415	14.1	3.00	0.40
1 year	245	14.3	4.71	0.43
2 years	255	14.9	4.73	0.36
3 to <6 years	543	14.3	4.40	0.25
6 to <11 years	894	14.0	4.64	0.16
11 to <16 years	1,451	14.2	5.21	0.10
16 to <21 years	1,182	13.6	4.76	0.07
21 to <31 years	1,023	12.6	4.19	0.06
31 to <41 years	869	12.3	4.33	0.06
41 to <51 years	763	12.2	4.75	0.06
51 to <61 years	622	12.7	4.96	0.07
61 to <71 years	700	14.3	4.89	0.07
71 to <81 years	470	15.4	4.95	0.07
81 years and older	306	16.5	4.89	0.08

Table 4-2b. Average time spent per day performing activities within specified intensity categories, and average ventilation rates associated with these activity categories, for females according to age category (continued)

Age Category	# NHANES Participants Reporting Activity	Average Duration (hr/day) Spent at Activity	Ventilation Rate During this Activity ^a	
			Unadjusted for Body Weight (L/min)	Adjusted for Body Weight (L/min-kg)
Light-Intensity Activities (1.5 < METS ≤ 3.0)				
Birth to <1 year	415	6.0	7.32	0.98
1 year	245	5.6	11.62	1.05
2 years	255	5.8	11.99	0.90
3 to <6 years	543	6.3	10.92	0.62
6 to <11 years	894	7.3	11.07	0.38
11 to <16 years	1,451	7.6	12.02	0.23
16 to <21 years	1,182	7.0	11.08	0.17
21 to <31 years	1,023	6.4	10.55	0.15
31 to <41 years	869	6.5	11.07	0.15
41 to <51 years	763	6.6	11.78	0.16
51 to <61 years	622	6.5	12.02	0.16
61 to <71 years	700	6.2	10.82	0.15
71 to <81 years	470	6.0	10.83	0.16
81 years and older	306	5.3	10.40	0.17
Moderate-Intensity Activities (3.0 < METS ≤ 6.0)				
Birth to <1 year	415	3.9	13.98	1.87
1 year	245	4.0	20.98	1.90
2 years	255	3.3	21.34	1.60
3 to <6 years	543	3.4	20.01	1.14
6 to <11 years	894	2.6	21.00	0.72
11 to <16 years	1,451	2.0	23.55	0.44
16 to <21 years	1,182	3.3	23.22	0.36
21 to <31 years	1,023	4.8	22.93	0.33
31 to <41 years	869	5.0	22.70	0.32
41 to <51 years	763	5.0	24.49	0.33
51 to <61 years	622	4.6	25.24	0.34
61 to <71 years	700	3.3	21.42	0.29
71 to <81 years	470	2.5	21.09	0.31
81 years and older	306	2.1	20.87	0.33

Table 4-2b. Average time spent per day performing activities within specified intensity categories, and average ventilation rates associated with these activity categories, for females according to age category (continued)

Age Category	# NHANES Participants Reporting Activity	Average Duration (hr/day) Spent at Activity	Ventilation Rate During this Activity ^a	
			Unadjusted for Body Weight (L/min)	Adjusted for Body Weight (L/min-kg)
High-Intensity Activities (METS > 6.0)				
Birth to <1 year	79	0.2	24.19	3.26
1 year	55	0.2	36.48	3.38
2 years	130	0.2	37.58	2.80
3 to <6 years	347	0.2	34.53	1.98
6 to <11 years	707	0.2	39.39	1.33
11 to <16 years	1,170	0.3	46.56	0.88
16 to <21 years	887	0.2	44.09	0.70
21 to <31 years	796	0.3	45.68	0.65
31 to <41 years	687	0.2	44.44	0.61
41 to <51 years	515	0.3	46.98	0.65
51 to <61 years	424	0.3	47.35	0.63
61 to <71 years	465	0.3	40.02	0.54
71 to <81 years	304	0.3	40.64	0.59
81 years and older	188	0.3	41.88	0.67

^aAn individual's \dot{V}_E for the given activity category equals the weighted average of the individual's activity-specific \dot{V}_E s for activities falling within the category, estimated using the multiple linear regression model in Section 3.6, with weights corresponding to the number of minutes spent performing the activity. Numbers in these two columns represent averages, calculated across individuals in the specified age category, of these weighted averages. These are weighted averages, with the weights corresponding to the 4-year sampling weights assigned within NHANES 1999–2002.

Additional descriptive statistics to accompany the results in Tables 4-2a and 4-2b can be found in Table C-3 through Table C-7 in Appendix C. These five tables summarize the following:

- Duration of time spent performing activities (hr/day)
- Average \dot{V}_E (L/min and m³/min), unadjusted for body weight
- Average \dot{V}_E (L/min/kg and m³/min/kg), adjusted for body weight

4.1. STRENGTHS AND LIMITATIONS

The major strengths of the approach applied in this document (and detailed in Appendix A) are that it accounts for differences in \dot{V}_E that occur due to activity level, the effect of age and gender, and variation between individuals. The approach yields an estimate of \dot{V}_E that is a function of VO_2 rather than an indirect measure of oxygen consumption such as VQ . (While other researchers have estimated \dot{V}_E given VQ , the appropriate value of VQ to use can depend on an individual's work rate, and thus, can introduce bias and additional variability.) The primary sources of input data to this approach, the NHANES and NHAPS data sets, are each nationally representative data sets with a large sample size, even within the age and gender categories considered in this document, thereby allowing for improved characterization of body weight and activity patterns that can represent everyone in an age/gender subpopulation. However, in the prediction of \dot{V}_E from VO_2 , there is, admittedly, limited data available in the literature on diverse groups of people varying in age, gender, body weight, and other relevant factors.

By simulating an individual's 24-hour activity pattern based on information for a subpopulation with the same age and gender range, this approach attempted to address the correlation that is present between an individual's BMR measure and the METS values associated with the activities that the individual performs. However, because the NHAPS database within CHAD does not include body weight, information on both METS values and BMR were not available for an individual that would allow a more rigorous characterization, such as taking into account correlation among the incidence and duration of certain activity

types. This was one limitation of the analysis outcome. While other data sources within CHAD, which did include body weight were considered, they were deemed to have limited target populations that would have limited the ability to infer findings to larger populations.

To determine an individual's BMR, EPA utilized a series of equations proposed by Schofield (1985) that predicted BMR as a function of body weight, gender, and age category. While this set of equations was deemed to represent the general U.S. population more completely than any other available BMR estimating procedures, there are some limitations associated with their use. For example, the equations are based on studies that have become considerably dated in recent years, and, therefore, may be less representative of current populations (especially in young children). Some researchers question the extent of uncertainty that may be introduced by expressing BMR as a strictly linear function of body weight, as the Schofield equations do. Despite these limitations, the derivation and application of the Schofield equations have been subject to independent technical review in scientific publications. They remain the best available tool for U.S. EPA in calculating BMR from body weight for the general population.

The simulated 24-hour activity pattern assigned to an NHANES participant is likely to contain a greater variety of different types of activities than one person may typically experience in a day. Furthermore, a particular activity may be represented within an activity pattern for a shorter duration than what may be typical for a person. The durations of different intensity levels summarized in Table C-3 of Appendix C across the simulated activity patterns appear to be within reason for each age category.

The approach does not specifically account for uncertainty that is introduced by assigning a random METS value to an activity that originates from a pre-specified statistical distribution. In addition, a potential bias may be introduced if this distribution is not appropriate in reality for a given activity, although the CHAD identified appropriate distributions based upon a review of the exercise physiology and clinical nutrition literature. The METS randomization process allows for different METS values to be assigned to the same activity being performed by the same individual at a given moment in time. There is both variability associated with this METS randomization process as well as variability in METS values that is present from one individual to another. The variability in METS values that is present from one individual to another confounds the variability associated with the METS randomization process.

By using the NHANES sampling weights in the calculation of the statistics in this document, the goal of this effort was to generate statistics that could represent national estimates. In the calculation, use of the sample weights is preferable to ignoring them. However, because the 24-hour activity pattern assigned to each NHANES individual was simulated using activity information from the NHAPS study, the observed distribution of \dot{V}_E values across individuals can only approximate a national distribution. In addition, because the simulated 24-hour activity patterns are limited to the set of activities reported within the NHAPS database, and because each simulated pattern represented an average of multiple patterns observed within the NHAPS database, an individual's true activity pattern in any given 24-hour period may be more variable than that considered in this exercise. Furthermore, because the simulated activity profiles did not consider possible limits on the "maximum possible METS value" that would account for previous activities, \dot{V}_E s may be overestimated as a result.

Data from the NHAPS were used to characterize activity levels for individuals in the U.S. population. Because the NHAPS was conducted over 10 years ago, it may not accurately portray activity profiles in certain subpopulations, especially those seeing greater trends toward overweight incidence and obesity (e.g., children and adolescents). In addition, the growing sedentary nature of the population as a whole may be affecting the continued relevance of NHAPS activity data to the contemporary U.S. population. METS distributions also may not be adequately characterized when activities are conducted by children, due to the more frequent and sudden movement by children from one activity to another compared to other subpopulations. Lastly, the survey's practice of retrospectively providing activity information may result in less accurate and less detailed information than studies that use prospective, real-time diaries that subjects would complete after participation in each activity. While U.S. EPA recognizes and considered these limitations, the several advantages associated with the NHAPS data remained important, and, therefore, led to accepting the data for use in this analysis.

In order to assess the impact of these limitations, a validation exercise was conducted to compare results presented in this document with values published in the literature using two other methodologies. These methodologies include the use of doubly labeled water for estimating EE (Brochu et al., 2006a, b) and the use of food-energy intakes from nationwide food intake surveys to estimate EEs (Layton, 1993; Arcus-Arth and Blaisdell, 2007). Appendix D shows how the results from the metabolically derived methodology compares with the values

reported by Brochu et al. (2006a, b) and Arcus-Arth and Blaisdell (2007). Mean estimates for all of the physiological parameters generated by APEX including \dot{V}_E s are reasonably correlated with independent measures from the Brochu et al. (2006a, b) estimates, particularly when correcting the Brochu et al. (2006a) ventilation estimates for children using a more appropriate estimate of VQ for children. The results of this exercise suggest that despite the different methodologies and data sources, the resulting APEX-derived mean ventilation estimates compare favorably to those of these two other methods. It should be noted, however, that upper percentile values may be more uncertain. These values tend to equate to unusually high estimates of caloric intake per day and are unlikely to represent an average individual. Although the three methodologies available to estimate \dot{V}_E s (i.e., doubly labeled water, food-energy consumption, and metabolically-derived \dot{V}_E s) have different strengths and limitations, they complement each other in providing useful information on \dot{V}_E s.

REFERENCES

- Adams, WC; Shaffrath, JD; Ollison, WM. (1995) The relation of pulmonary ventilation and heart rate in leg work alone, arm work alone, and in combined arm and leg work. Paper WA-84A.04 presented at the 88th Annual Air & Waste Management Association Conference. 21 June 1995.
- Adams, WC. (1993) Measurement of breathing rate and volume in routinely performed daily activities. California Environmental Protection Agency, Air Resources Board. Final Report, Contract No. A033-205. Available online at <http://www.arb.ca.gov/research/apr/past/a033-205.pdf>
- Arcus-Arth, A; Blaisdell, RJ. (2007) Statistical distributions of daily breathing rates for narrow age groups of infants and children. *Risk Anal* 27(1):97–110.
- Brochu, P; Ducré-Robitaille, J; Brodeur, J. (2006a) Physiological daily inhalation rates for free-living individuals aged 1 month to 96 years, using data from doubly labeled water measurements: a proposal for air quality criteria, standard calculations and health risk assessment. *Hum Ecol Risk Assess* 12(4):675–701.
- Brochu, P; Ducré-Robitaille, J; Brodeur, J. (2006b) Physiological daily inhalation rates for free-living pregnant and lactating adolescents and women aged 11 to 55 years, using data from doubly labeled water measurements for use in health risk assessment. *Hum Ecol Risk Assess* 12(4):702–735.
- CDC (Centers for Disease Control and Prevention). (2000) National Health and Nutrition Examination Survey (NHANES) 1999-2000. U.S. Department of Health and Human Services, National Center for Health Statistics (NCHS), Hyattsville, MD. Available online at http://www.cdc.gov/nchs/about/major/nhanes/nhanes99_00.htm
- CDC (Centers for Disease Control and Prevention). (2002) National Health and Nutrition Examination Survey (NHANES) 1999-2000. U.S. Department of Health and Human Services, National Center for Health Statistics (NCHS), Hyattsville, MD. Available online at <http://www.cdc.gov/nchs/about/major/nhanes/nhanes01-02.htm>.
- CDC (Centers for Disease Control and Prevention). (2005) Analytic and reporting guidelines The national health and nutrition examination survey (NHANES). National Center for Health Statistics, Centers for Disease Control and Prevention, Hyattsville, MD. December 2005. Available online at http://www.cdc.gov/nchs/data/nhanes/nhanes_03_04/nhanes_analytic_guidelines_dec_2005.pdf.
- CDC (Centers for Disease Control and Prevention). (2004) NHANES analytic guidelines. National Center for Health Statistics, Centers for Disease Control and Prevention, Hyattsville, MD. June 2004. Available online at http://www.cdc.gov/nchs/data/nhanes/nhanes_general_guidelines_june_04.pdf.
- Derumeaux-Burel, H; Meyer, M; Morin, L; et al. (2004) Prediction of resting energy expenditure in a large population of obese children. *Am J Clin Nutr* 80(6):1544–1550.
- Hebestreit, H; Staschen, B; Hebestreit, A. (2000) Ventilatory threshold: a useful method to determine aerobic fitness in children? *Med Sci Sports Exerc* 32(11):1964–1969.
- Hebestreit, H; Kriemler, S; Hughson, RL; et al. (1998) Kinetics of oxygen uptake at the onset of exercise in boys and men. *J Appl Physiol* 85(5):1833–1841.
- Klepeis, NE; Nelson, WC; Ott, WR; et al. (2001) The national human activity pattern survey (NHAPS): a resource for assessing exposure to environmental pollutants. *J Expo Anal Environ Epidemiol* 11(3):231–252.
- Johnson, T. (2002) A guide to selected algorithms, distributions, and databases used in exposure models developed by the office of air quality planning and standards. Prepared for the U.S. Environmental Protection Agency, Office of Research and Development, RTP, NC. Prepared by TRJ Environmental, Chapel Hill, NC. Available online at <http://www.epa.gov/ttn/fera/data/human/report052202.pdf>.

- Layton, DW. (1993) Metabolically consistent breathing rates for use in dose assessments. *Health Phys* 64(1):23–36.
- McCurdy, TR. (2000) Conceptual basis for multi-route intake dose modeling using an energy expenditure approach. *J Expo Anal Environ Epidemiol* 10:86–97.
- McCurdy, TR; Glen, G; Smith, L; et al. (2000) The National Exposure Research Laboratory's consolidated human activity database. *J Expo Anal Environ Epidemiol* 10:566–578.
- McCurdy TR; Graham, SE. (2004) Analyses to understand relationships among physiological parameters in children and adolescents aged 6–16. U.S. Environmental Protection Agency, Office of Research and Development, National Exposures Research Laboratory, Research Triangle Park, N. Carolina. EPA/600/X-04/092.
- SAS (2005) SAS OnlineDoc® 9.1.3. Cary, NC: SAS Institute, Inc. Available online at <http://support.sas.com/onlinedoc/913/docMainpage.jsp>.
- Schofield, WN. (1985) Predicting basal metabolic rate, new standards and review of previous work. *Hum Nutr Clin Nutr.* 39(Suppl.):5–41.
- USDA (Department of Agriculture). (2000) Continuing survey of food intake by individuals (CSFII) 1994-96, 98. U.S. Department of Agriculture, Agricultural Research Service, Beltsville, MD. Available from the National Technical Information Service (NTIS), Springfield Va, PB2000-500027.
- U.S. EPA (Environmental Protection Agency). (1997) Exposure factors handbook. Office of Research and Development, National Center for Environmental Assessment, Research Triangle Park, NC. Available online at <http://www.epa.gov/ncea/pdfs/efh/front.pdf>.
- U.S. EPA (Environmental Protection Agency). (2002) CHAD user's guide: extracting human activity information from CHAD on the PC. Prepared by ManTech Environmental Technologies and modified March 22 2002 by Science Applications International Corporation for the National Exposure Research Laboratory, U.S. Environmental Protection Agency. Research Triangle Park, NC. Available online at http://www.epa.gov/chadnet1/reports/CHAD_Manual.pdf.
- U.S. EPA (Environmental Protection Agency). (2005) Guidance on selecting age groups for monitoring and assessing childhood exposures to environmental contaminants. Risk Assessment Forum, Washington, DC. EPA/630/P-03/003F. November 2005. Available online at <http://cfpub.epa.gov/ncea/cfm/recordisplay.cfm?deid=146583>.
- U.S. EPA (Environmental Protection Assessment). (2008) Child-specific exposure factors handbook (CSEFH). National Center for Environmental Assessment, Washington, DC, EPA/600/R-06/096F, October, 2008. Available online at <http://cfpub.epa.gov/ncea/cfm/recordisplay.cfm?deid=199243>.

APPENDIX A:

**Revised Ventilation Rate (V_E) Equations for Use
in Inhalation-Oriented Exposure Models**

by

**S. Graham and T. McCurdy
EPA/600/X-05/008**

Disclaimer to Appendix A

This document has been reviewed in accordance with U.S. Environmental Protection Agency policy and approved for publication. Mention of trade names or commercial products does not constitute endorsement or recommendation for use.

Abstract to Appendix A

Using data compiled from 32 clinical exercise studies, algorithms were developed to estimate body mass-normalized ventilation rate (V_E , L/min-kg) for 4 age groups (<20, 20-<34, 34-<61, 61+ years of age) and both genders. The algorithms account for differences in ventilation rate due to activity level, variability within age groups, and variation both between and within individuals. A multiple linear regression (MLR) model was first used to estimate significant explanatory parameters ($p < 0.01$) following natural log (Ln) transformation of body mass (BM) normalized oxygen consumption rate (VO_2). Log transformed age (Ln(age)), gender (-1 for males, 1 for females), and Ln(VO_2/BM) served as independent variables and regressed on multiple V_E measurements that were collected during incremental exercise to obtain regression parameter estimates. The (MLR) model showed marginal statistical improvement ($R^2 + 5\%$) in comparison with a previous simple linear regression model for estimating V_E , however the MLR can estimate population V_E with one-half the equations formerly used and can be used to address uncertainty in V_E estimations. A mixed-effects regression (MER) model was then constructed utilizing the independent variables as fixed parameters and retaining individuals and study of origin as random effects variables. The MER model was used to allocate the random error (ϵ) to between-person residuals distributions (inter-individual variability) and within-person residuals distributions (intra-individual variability). Predictive equations were executed for 5,000 iterations at a given age (e.g., 5 year olds) or age group classification (e.g., 45-55 years old) and estimated ventilation rates for each model were compared at their respective 50th, 95th and 99th percentiles. U.S. EPA's Air Pollution Exposure (APEX) model was used to estimate population ventilation rates using a variety of ventilation algorithms for comparison with the MLR and MER at individual years in age. V_E estimations from the MLR and MER algorithms were similar across all ages and provided reasonable ventilation rates at all percentiles and ages, suggesting either approach is reasonable for stochastic modeling exercises where simulation of activity-specific person-oriented ventilation rates is desired.

Keywords / Acronyms

APEX	Air Pollution Exposure model (OAQPS)
BMR	Basal metabolism rate
BM	Body mass
BMI	Body mass index
BSA	Body surface area
CHAD	Consolidated Human Activity Database
EE	Energy expenditure
EVR	Equivalent ventilation rate [V_E/BSA]
F_i	Conversion Factors
HR	Heart rate
HT	Height
LBM	Lean Body Mass (equivalent to fat-free mass)
METS	Metabolic equivalents of work
NAAQS	National Ambient Air Quality Standard
NERL	National Exposure Research Laboratory
OAQPS	Office of Air Quality Planning and Standards
Pa_{CO_2}	partial pressure of arterial carbon dioxide
RQ	Respiratory quotient ($\dot{V}_{CO_2} / \dot{V}_{O_2}$)
SHEDS	Stochastic Human Exposure and Dose Simulation model (NERL)
\dot{V}_A	Alveolar ventilation rate (due to formatting issues, V_A is used in report)
\dot{V}_{CO_2}	Carbon dioxide expiration rate
V_D	Dead space volume of the lung
\dot{V}_E	Total ventilation rate (due to formatting issues, V_E is primarily used here)
V_T	Tidal volume of the lung
\dot{V}_{O_2}	Oxygen consumption rate (due to formatting issues, VO_2 is primarily used here)
VQ	Ventilatory equivalent ($\dot{V}_E / \dot{V}_{O_2}$)

Acknowledgments

The authors are indebted to a number of people who invested time in improving this report. Special thanks are due our OAQPS colleagues who shared their expertise in human exposure modeling and risk assessment which helped focus our efforts; they are, in particular: John Langstaff, Ted Palma, and Harvey Richmond. Gratitude is also due to Ted Johnson of TRJ Environmental, who provided us with information on past practices regarding uptake dose modeling. Finally, we thank our U.S EPA colleague, Dr. James Starr who reviewed this report and discussed ventilation issues with us.

Table of Contents

1. Introduction.....	A-1
2. Methods.....	A-3
Data Set Description	A-3
Statistical Analysis.....	A-3
Algorithm Evaluation.....	A-5
3. Results and Discussion	A-6
Statistical Analysis.....	A-6
Extrapolation Issues and Assumptions	A-9
Performance Evaluation.....	A-11
4. Recommendations.....	A-15
5. Future Research	A-15
6. References.....	A-16
Attachment A1	A-199
Attachment A2	A-31
Attachment A3	A-355

List of Tables

Table A-1.	Parameter estimates used to estimate activity-specific VO_2 for males and females of different age groups	A-5
Table A-2.	Parameter and residuals distribution estimates derived from two different statistical techniques and reported from Johnson (2002) for use in predictive equation (1) or (2)	A-7
Table A-3.	Ventilation parameter estimates (b_i), standard errors (se), and residual distributions standard deviation estimates (e_i) using Adams data and assuming equation (3) or (4)	A-9
Table A-4.	Residual distributions standard deviation estimates (e_b and e_w) using data characterized by percentage of maximum VO_2 (VO_{2m}) assuming equation (3)	A-10
Table A-5.	Residual distributions standard deviation estimates (e_b and e_w) using data categorized by percentage of maximum VO_2 (VO_{2m}) assuming equation (4)	A-10
Table A-6.	Recommended inhalation rates (L/min) from U.S. EPA (1997) Table 5-23	A-12
Table A1-1.	Total subjects for each study, gender, and exercise ergometry used	A-20

List of Figures

Figure A-1.	Pathways for estimating various ventilation parameters and metrics	A-1
Figure A-2.	Ventilatory quotient (VQ) as a function of age during exercise	A-8
Figure A-3.	Estimated ventilation rates (V_E , L/min) for females (left) and males (right) while performing low-level (top), moderate (middle), and vigorous (bottom) activities	A-13
Figure A-4.	Estimated population ventilation rates (V_E , L/min) for 20,000 persons using APEX and the mixed effects regression (MER) algorithm (Equation 4 and Table 3)	A-14
Figure A2-1.	Relationship between total ventilation rate (V_E) and oxygen consumption rate (VO_2) during exercise	A-33
Figure A2-2.	Relationship between body mass normalized total ventilation rate (V_E/BM) to oxygen consumption rate (VO_2/BM) during exercise	A-33
Figure A2-3.	Relationship between the natural logarithm of total ventilation rate $\ln(V_E)$ and oxygen consumption rate $\ln(VO_2)$ during exercise	A-34
Figure A2-4.	Relationship between body mass normalized total ventilation rate $\ln(V_E/BM)$ to oxygen consumption rate $\ln(VO_2/BM)$ during exercise	A-34
Figure A3-1.	Comparison of selected percentiles of estimated event-based ventilation rates from 20,000 person APEX model simulation using different ventilation algorithms	A-37
Figure A3-2.	Comparison of estimated event-based ventilation rate percentiles from 20,000 person APEX model simulation using mixed effects regression (MER-left) and Johnson (2002) (right) ventilation algorithms	A-38
Figure A3-3.	Percent difference of estimated event-based ventilation rate percentiles from 20,000 person APEX model simulation using mixed effects regression (MER-left) and Johnson (2002) (right) ventilation algorithms ...	A-39

1. Introduction

The use of population-based probabilistic exposure models in risk assessments has increased over the past few decades, largely due to their ability to simulate human activities more realistically than previous models that used mostly static but conservative estimates of physiologic parameters such as ventilation rate (\dot{V}_E , commonly in $L \text{ min}^{-1}$). Some of the early, more advanced human exposure models were developed by U.S. EPA's Office of Air Quality Planning and Standards (OAQPS) in the 1980s, each containing an inhalation dose metric since their inception (Johnson, 1995; McCurdy, 1994a, 1995). The first series of these models were known as NAAQS Exposure Model NEM and probabilistic NEM (pNEM) models. The ventilation algorithm became more detailed over time, culminating with equivalent ventilation rate (EVR; \dot{V}_E normalized to body surface area (BSA)) and alveolar ventilation rate (\dot{V}_A) estimations used by a number of the pNEM models that are described in numerous OAQPS-sponsored papers and reports (Johnson, 2002; Johnson and Adams, 1994; Johnson and Capel, 2002; Johnson et al., 1995, 1996; Johnson and McCoy, 1995; McCurdy, 1994b; and McCurdy, 1997a). More recently, the National Exposure Research Laboratory (NERL) has developed the Stochastic Human Exposure and Dose Simulation (SHEDS) model, essentially adopting the ventilation algorithm used in OAQPS's Air Pollution Exposure (APEX) model, itself a variant of the pNEM models. The impact of using advanced procedures for dose rate metrics has been evaluated by McCurdy (1997b, c); however an integrated approach for estimating multiple ventilation parameters has not yet been developed.

To estimate inhalation exposure and dose in these fairly complex models, a standard but flexible algorithm is required. One that not only addresses variability in breathing rates but can simulate differences in the site of action of pollutants within the respiratory system (e.g., ozone, particulate matter deposition) and variable chemical uptake characteristics (e.g., absorption across the alveolar membrane versus total absorption). Using current U.S. EPA exposure model approaches for approximating ventilation rates and considering the need to address ventilation for multiple classes of pollutants, a framework of activity-specific ventilation parameters was constructed and is depicted in Figure A-1.

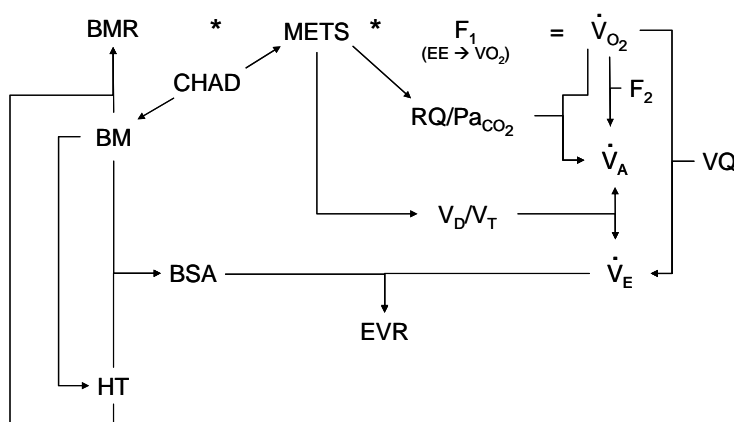

Figure A-1. Pathways for estimating various ventilation parameters and metrics.

Central to the framework is the U.S. EPA's Consolidated Human Activity Database (CHAD), a database of nearly 23,000 person-days of time-location-activity data useful for exposure modeling purposes (McCurdy et al., 2000). Distributions of metabolic equivalents (METS) are assigned in CHAD to every activity that respondents participated in. These METS distributions have been developed from a review of the exercise physiology and clinical nutrition literatures (McCurdy, 2000) and represent the ratio of the energy needed for the activity performed to the energy needed to sustain life (basal metabolism). The METS are fundamental to simulating an individual's breathing rate while the person is performing a variety of activities (e.g., running, walking, sleeping).

To estimate activity-specific ventilation rates, first a prediction equation for basal metabolic rate (BMR, in kilocalories min^{-1}) is used to estimate the simulated individual's resting metabolic rate from their body mass (BM), or from BM and height (HT) together. Then activity-specific METS (METS_A) are sampled via Monte-Carlo techniques and multiplied by a person's estimated BMR to obtain a single realization of the energy expenditure rate (EE, kilocalories min^{-1}). This rate of energy expenditure is retained over the duration of the activity (termed here as an "event"), which can be as short as 1 minute or as long as one hour (due to the structure of CHAD).

Thus mathematically, event-specific EE for an individual (EE_{Ei}) is defined as:

$$\text{EE}_{Ei} = \text{BMR}_i * \text{METS}_A$$

Estimated EE_{Ei} can then be converted to an activity-specific oxygen consumption rate (VO_{2Ei}) using a gender-specific relationship expressed as a uniform distribution (F_{1i} , L- O_2 /kilocalorie) (McCurdy, 2000) as follows:

$$\text{VO}_{2Ei} = \text{EE}_{Ei} * F_{1i}$$

VO_2 , however, is not the final physiological process to be simulated since most air pollution clinical studies do not use it as the end-point ventilation metric. Most of these studies use V_E or EVR, and some exposure models, particularly OAQPS's APEX model for carbon monoxide (APEX-CO), need V_A (commonly in L min^{-1}) for their inhalation modeling approach. By definition, V_A is a fraction of V_E and is important in estimating respiratory uptake of gases (e.g., O_2 , CO, CO_2) and chemicals that likely act as gases (e.g., benzene, 1-3-butadiene [Lin, et al., 2001]). Regardless, all three mentioned ventilation metrics (V_E , EVR, V_A) can be obtained from VO_2 , either directly or indirectly, thus VO_2 is fundamental to the development of each of these ventilation algorithms.

The pathway from VO_2 to V_E can be direct or indirect, with the indirect approach itself having a few options: from VO_2 to V_A and then to V_E , or from VO_2 to V_E using the ventilatory quotient (VQ or alternatively, the ventilatory equivalent). VQ is simply the unitless ratio of V_E to VO_2 when both metrics are in the same units. This ratio is non-linear with work rate however, varying between 20 and 32 in healthy people at low-to-moderate work rates while higher at more extreme exercise levels (McArdle et al., 1991). While there are nuances among the many ways

that V_E and EVR have been estimated over the years, in general the approach taken has been the VQ pathway depicted in Figure A-1. V_A has been estimated by Johnson (2002) using a direct relationship between VO_2 and V_A originally described by Galletti (1959). For a more complete discussion of how ventilation rate has been modeled by OAQPS, see Section 9 of Johnson (2002).

This NERL Research Report describes an approach to estimating V_E directly from VO_2 using a series of regression-based equations derived from 25 years of clinical studies conducted by Dr. William C. Adams of the University of California at Davis. Much of the work cited above has been predicated upon past work and data provided by Dr. Adams, particularly Adams (1993) and Adams et al. (1995). OAQPS and NERL at different times acquired independent (non-overlapping) data sets from his laboratory at the University of California-Davis. These data have been extensively analyzed by OAQPS contractors, particularly Ted Johnson of TRJ Environmental (and previously with IT Technology). In addition to the citations noted above regarding analysis of Dr. Adams' data, see also Johnson et al. (1998).

OAQPS requested that staff in the Exposure Modeling Research Branch of NERL review the literature on calculating V_A since a previous review of the algorithms used in pNEM/CO indicated that a constant in the equation possibly varied non-linearly with exercise rate. That review has not been completed as of this date, but as an outgrowth of this work NERL staff decided to first investigate a V_E algorithm for use in both the APEX and SHEDS inhalation modules. It is this work that is described below.

2. Methods

Data Set Description

The data set acquired is listed and briefly described in communication memos authored by Dr. Adams and provided in Attachment A1. Data from 32 panel studies collected over a 25-year period by the same laboratory were obtained in electronic format. The number of subjects included within these studies was nearly one-thousand, undoubtedly one of the largest datasets of its kind. The data set used was a Microsoft® Excel (.xls) file obtained from a disk labeled "Converted Adams Data". The file used in this analysis (adam2.xls) was considered as the raw data file, since also on this disc was included an ASCII text version of the file and the memo from Dr. Adams describing the data set.

The raw data required physical manipulation and mathematical transformation to allow for statistical analyses. Details of the procedures used as part of this research are described further in Attachment A2. Briefly, due to the format of the original study data sets, a file was created containing a single vector for each individual ventilation parameter. Data were then screened for erroneous and potentially extreme values. Ventilation parameters (V_E and VO_2) were normalized to body mass and followed with a natural logarithm (Ln) transformation.

Statistical Analysis

All statistical analyses were performed using SAS® software, version 8.2.1 (SAS Institute, Cary, NC). Parameters considered useful in model simulations (i.e., those that could capture a significant degree of variability and are consistent with current exposure modeling

structure) were first evaluated for statistical significance ($p < 0.01$) using an analysis of variance (ANOVA). Then, a simple linear regression (SLR) model was developed of the form $y_i = b_0 + b_1x_i + \varepsilon_i$ to estimate parameter coefficients for use in predictive equations:

$$\text{Ln}(V_E/\text{BM})_i = b_0 + (b_1 * \text{Ln}(\text{VO}_2/\text{BM}_i)) + e_i \quad \text{Eq. (1)}$$

where b_0 = the regression intercept, b_1 = the regression slope coefficient, and e_i representing individual variability in ventilation rate. The coefficient of determination (R^2) was used in evaluating the regression model since it represents the proportion of total variance of the dependent variable “explained” by the independent variables.

The approach was modified slightly for predictive purposes to reflect additional test factors contributing to variance in the ventilation rate. The model presented here was given as Equation 9-6 in Johnson (2002) and interpreted as follows, where b_0 = the intercept and b_1 = the slope regression coefficient:

$$\text{Ln}(V_E/\text{BM})_i = b_0 + (b_1 * \text{Ln}(\text{VO}_2/\text{BM}_i)) + e_{bi} + e_{wi} \quad \text{Eq. (2)}$$

It was assumed here that the predictive regression equation represents a mixed-effects regression (MER) model containing both fixed and random effects variables. VO_2 was considered a fixed parameter and subject and study were random effects variables used to estimate the between-person (inter-individual variability) residuals distribution (e_b) and within-person (intra-individual variability) residuals distribution (e_w) rather than simply random error (ε) alone. Each of the residuals are normally distributed, with a mean of 0 and an estimated standard deviation of σ^2 (i.e., $N\{0, \sigma^2\}$). Statistical significance of estimated coefficients and the regression model was assessed at $p < 0.01$. The purpose of this regression analysis was to duplicate the model presented by Johnson (2002) and provide standard errors associated with the parameter estimates.

Finally, multiple linear regression (MLR; $y_i = b_0 + b_1x_{i1} + b_2x_{i2} + \dots + b_px_{ip} + \varepsilon_i$) was implemented to include both *age* and *gender* as independent variables:

$$\text{Ln}(V_E/\text{BM})_i = b_0 + (b_1 * \text{Ln}(\text{VO}_2/\text{BM}_i)) + (b_2 * \text{Ln}(\text{age}_i)) + (b_3 * \text{gender}_i) + e_i \quad \text{Eq. (3)}$$

The age of each study subject was transformed by the natural logarithm. Gender was used as a classification variable, with males represented by -1 and females represented by 1. The regression was set in this manner to provide for reasonable estimation of ventilation rates even if gender was unknown ($\text{gender}=0$). Random error (ε) can also be allocated to two variance components as described above for equation (2) using a MER model that includes age and gender as additional variables. This new model is represented as:

$$\text{Ln}(V_E/\text{BM})_i = b_0 + (b_1 * \text{Ln}(\text{VO}_2/\text{BM}_i)) + (b_2 * \text{Ln}(\text{age}_i)) + (b_3 * \text{gender}_i) + e_{bi} + e_{wi} \quad \text{Eq. (4)}$$

Statistical significance of estimated coefficients and the regression model was assessed at $p < 0.01$.

Modification of the age groupings originally developed by Johnson (2002) was performed to determine if the statistical performance of the predictive equations could be improved. Criteria for the model development included individual regression coefficient significance (*p*- or *t*-value), total model explanatory power (R^2), and stability of the regression coefficients. For this last criterion, it was desired that coefficients neither greatly increase nor decrease in the individual regression equations compared with previous coefficient estimates while expanding/compressing age classifications. Age groupings were varied by one-year increments until the evaluation criteria described above was optimized, that is, models containing the greatest R^2 , with statistically significant coefficients that varied minimally were retained.

Algorithm Evaluation

Each of the algorithms for estimating ventilation were evaluated using one or both methods described below to determine the range possible outcomes for individuals and a population. Selected evaluations for the MLR and MER (using equations 3 and 4, respectively) are presented in the main text, while additional evaluations are provided in Attachment A3.

Ventilation rates were first estimated using Crystal Ball™ software (Decisioneering, Inc., Denver Colorado). Age- and gender-specific body weights for simulated individuals were estimated by probabilistic sampling of distributions provided by Burmaster and Crouch (1997). Basal metabolic rate was estimated using age- and gender-specific equations presented in Schoefield (1985), with age itself being sampled from uniform distributions within the age groupings used in our analyses. Activity-specific VO_2 was generated using METS distributions for low, moderate, and vigorous intensity activities combined with the unit conversions given in Table A-1. Ventilation rates were estimated for 5,000 hypothetical persons within each age (or age grouping) and gender category using predictive equations (3) and (4) and their respective parameters. To estimate variability in ventilation rates, each of the residuals distributions were probabilistically sampled while the intercept and coefficients held as constants, thus each estimated ventilation rate is representative of one activity performed by one hypothetical individual. Median (p50), 95th (p95), and 99th (p99) percentiles of the hypothetical population distribution of estimated ventilation rates were compiled by age. The output represents the possible range of expected ventilation rates across the population at a moment in time.

Table A-1. Parameter estimates used to estimate activity specific VO_2 for males and females of different age groups.¹

Age group	Gender	METS-Activity Level ²			Conversion Factors	
		Low	Moderate	Vigorous	Energy to Oxygen (L-O ₂ /kcal)	Unit (MJ/kcal)/(min/day)
Child (0-18 yrs)	Male	N{2.0,0.34}	N{5.0,0.85}	N{9.0,1.5}	U{0.20-0.22}	239/1440
	Female	N{1.5,0.26}	N{4.5,0.77}	N{8.0,1.4}	U{0.19-0.21}	
Adult (>18 yrs)	Male	N{2.5,0.43}	N{6.5,1.1}	N{10,1.7}	U{0.20-0.22}	
	Female	N{2.0,0.34}	N{5.0,0.85}	N{9.0,1.5}	U{0.19-0.21}	

¹ Distribution type and parameters used: N=normal {arithmetic mean, standard deviation}; U=Uniform {min,max}.

² It was assumed that the relative standard deviation of the METS for each distribution was 17% (see McCurdy and Graham, 2004)

A second method for evaluation was conducted using OAQPS's APEX model, version 4.0 (see U.S. EPA, 2005 for details on the model algorithms). Twenty thousand individuals were simulated for one day to allow for the comparison of selected ventilation algorithms developed as would be used in an actual exposure model. Activity-specific ventilation rates were generated by APEX using human activity diaries from CHAD and the general approach described above and outlined in Figure A-1. Diaries in CHAD are at a minimum disaggregated to hourly components, that is, the maximum time step for an activity or location inhabited could be one hour, thus up to 24 events in a day. However much of the data are further divided such that within one hour there may be multiple activities performed or multiple locations inhabited, upwards to 1 minute in duration. Since every simulated individual had multiple estimations for ventilation rate depending on their activities performed (generally ranging from 30-40 events in a day), distributions were first calculated for each person followed by an estimate of the population distribution at each age (generally between 1 and 400 persons were simulated for each year of age). The median (p50), 95th (p95), and 99th (p99) percentiles and maximum ventilation rates estimated with the APEX model represent the variability in the mid-upper range of ventilation rates for individuals within a population. It should be noted that the maximum for all individuals is the same as the 99th percentile unless there was more than 99 events (rare if occurs at all).

3. Results and Discussion

Statistical Analysis

Both age and gender were used in the development of several regression equations derived from the Adams data set and summarized in Table 9-1 of Johnson (2002); however significance of these variables was not reported there. An analysis of variance was performed here on V_E , utilizing the 4 age groups (i.e., <18, 18-44, 45-64, >65 years old) and two genders as classification variables indicated by Johnson (2002). VO_2 normalized to body mass was included as an additional independent variable. Age group, gender, their interaction term (age group by gender), and VO_2 were each significant explanatory parameters (all $p < 0.003$).

Results of the simple linear regression analysis, the simple mixed model addressing fixed and random effects, and parameter coefficients reported by Johnson (2002) assuming equations (1) or (2) are presented in Table A-2. Regression model intercept and slope were statistically significant parameters in each of the regression models.

There were marginal differences between the simple regression coefficients and the simple mixed model coefficients developed in this work; both the intercepts and slopes were systematically lower for the simple regression. The results from the simple mixed model and Johnson (2002) were nearly identical with the most notable differences seen in the residuals distributions, albeit at a minimal level.

Following this single variable model comparison, age and gender were investigated as additional independent variables for use in a multiple linear regression model. Gender was already deemed significant based on the ANOVA and, since its use as a parameter in a multiple linear regression would halve the number of equations needed for ventilation simulations, was to be included as a parameter in the regression model. For age, it was hypothesized that it would

have a statistically significant effect on the relationship between V_E and VO_2 , not just among the different age groups but also within a given age group. Figure A-2 shows the relationship between VQ and age, with the most notable variation of VQ for those under age 18. These data (age<18) were not analyzed by Johnson (2002) due to lack of availability. Age, when included in a preliminary multiple regression model, was determined to be a significant explanatory parameter for both genders where age<18 and for males only within the other age groups (data not shown here). Estimated coefficients for the females, although not statistically significant, were generally consistent with those of the males.

When VQ was plotted by age (Figure A-2), it was observed that a few of the subjects contained excessive VQ values, such that further culling of the data set was warranted. Observations of VQ in excess of 50 were removed based on a review of the relevant literature undertaken as part of the work documented by McCurdy and Graham (2004). Based on this criterion, 13 data points were removed. No single subject had more than one data point removed. The impact of the additional culling was negligible (not reported).

Table A-2. Parameter and residuals distribution estimates derived from two different statistical techniques and reported from Johnson (2002) for use in predictive equation (1) or (2).

Age group	n	Gender	Method ^a	Ln(VO_2 /BM)				Residuals		R ²
				b ₀	se _{b0}	b ₁	se _{b1}	e _b	e _w	
<18	315	F	SLR	3.214	0.089	0.941	0.022	0.1609		0.8504
			MER	3.263	0.050	0.950	0.012	0.1427	0.0735	
			Johnson	<i>Not Performed</i>						
	288	M	SLR	3.054	0.103	0.913	0.026	0.1715		0.8069
			MER	3.180	0.052	0.941	0.012	0.1600	0.0722	
			Johnson	<i>Not Performed</i>						
18-44	1473	F	SLR	4.021	0.040	1.182	0.011	0.1736		0.8790
			MER	4.358	0.034	1.276	0.009	0.1351	0.1176	
			Johnson	4.357		1.276		0.1351	0.1182	
	3145	M	SLR	3.758	0.023	1.130	0.007	0.1826		0.8965
			MER	3.983	0.022	1.194	0.006	0.1219	0.1382	
			Johnson	3.991		1.197		0.1228	0.1395	
45-64	60	F	SLR	3.360	0.239	0.998	0.055	0.1401		0.8498
			MER	3.462	0.153	1.023	0.034	0.1152	0.0774	
			Johnson	3.454		1.021		0.1106	0.0769	
	641	M	SLR	3.824	0.060	1.117	0.016	0.1584		0.8884
			MER	4.019	0.047	1.166	0.012	0.1172	0.1073	
			Johnson	4.018		1.165		0.1107	0.1112	
65+	45	F	SLR	2.687	0.297	0.846	0.068	0.0960		0.7820
			MER	2.958	0.143	0.908	0.032	0.0920	0.0341	
			Johnson	2.956		0.908		0.0886	0.0338	
	317	M	SLR	3.686	0.090	1.060	0.023	0.1280		0.8729
			MER	3.731	0.055	1.071	0.013	0.1092	0.0632	
			Johnson	3.730		1.071		0.1082	0.0632	

a SLR: simple linear regression model (PROC REG in SAS) when using equation (1); MER: mixed effects regression model (PROC MIXED in SAS) when using equation (2); Johnson: data reported in Johnson (2002) for use with equation (2)

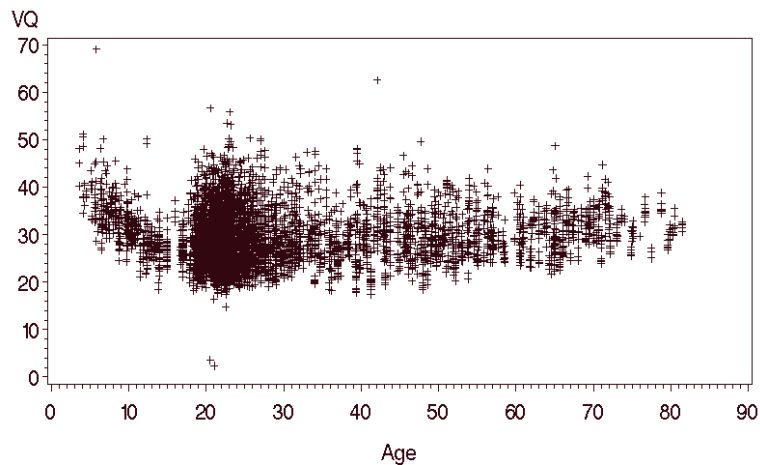

Figure A-2. Ventilatory quotient (VQ) as a function of age during exercise.

To determine optimum age groups for the final multiple linear regression model, the boundary values of the age groups--i.e., the youngest and oldest age groups determined by Johnson (2002) (<18 and 65+ years of age, respectively) were first evaluated. Based on the criteria described above, the lower and upper age groups were redefined to be <20 years old and >60 years old. Two “inner” age groupings (20 to <34; 34 to <61) were also optimized based on their fit with each other and with the lower and upper boundaries. The group comprising ages 34 to <61 could have been further subdivided (e.g., 34 to <45, 45 to <61 groups provided a good statistical fit based on the semi-quantitative criteria), however the regression coefficients for the intercept and age variables were dramatically altered for the 34-<45 age group (decreased and increased, respectively) in comparison with the other age groups. It is not apparent whether this response is physiologically representative of this age group, or that it is a function of the data set itself; therefore, the larger age grouping was retained.

Final ventilation parameter estimates for use in equations (3) or (4) following age group optimization are presented in Table A-2. Slightly improved explanatory power was achieved with the new models (as measured by the multiple linear regression model, about 90% of total variance is now explained) compared with the earlier analyses (on average 85%). Each of the regression models and all estimated coefficients were statistically significant ($p < 0.01$) except where noted.

Table A-3. Ventilation parameter estimates (b_i), standard errors (se), and residual distributions standard deviation estimates (e_i) using Adams data and assuming equation (3) or (4).

Age group	n	Method ^a	Ln(VO_2/BM)		Ln(age)		Gender		Residuals		R^2	
			b_0	se b_0	b_1	se b_1	b_2	se b_2	b_3	se b_3		e_b
<20	1085	MLR	4.4329	0.0579	1.0864	0.0097	-0.2829	0.0124	0.0513	0.0045	0.1444	0.9250
		MER	4.3675	0.0650	1.0751	0.0087	-0.2714	0.0190	0.0479	0.0077	0.0955	0.1117
20-<34	3646	MLR	3.5718	0.0792	1.1702	0.0067	0.1138	0.0243	0.0450	0.0031	0.1741	0.8927
		MER	3.7603	0.1564	1.2491	0.0061	0.1416	0.0493	0.0533	0.0061	0.1217	0.1296
34-<61	1083	MLR	3.1876	0.1271	1.1224	0.0120	0.1762	0.0335	0.0415	0.0095	0.1727	0.8925
		MER	3.2440	0.2578	1.1464	0.0088	0.1856	0.0674	0.0380 ^b	0.0172	0.1260	0.1152
61+	457	MLR	2.4487	0.3646	1.0437	0.0195	0.2681	0.0834	-0.0298	0.0100	0.1277	0.8932
		MER	2.5826	0.7013	1.0840	0.0122	0.2766	0.1652	-0.02081 ^c	0.0149	0.1064	0.0676

a MLR: multiple linear regression model (PROC REG in SAS) when using equation (3); MER: mixed-effects regression (PROC MIXED in SAS) when using equation (4); b $p=0.0286$; c $p=0.1656$.

Extrapolation Issues and Assumptions

Prior to algorithm evaluation, an analysis of the residuals distributions was first undertaken in a manner that mimicked the way the equations would be applied in human exposure modeling simulations. Note that all of the data were collected while individuals were performing exercise; however exposure modelers will commonly extrapolate the data to activity situations outside of the sample collection range. For example, when estimating a typical person's daily exposure, there is not a significant time spent exercising but more spent performing less strenuous activities such as sleeping. Since resting measurements were not collected by Dr. Adams for most of his subjects, an evaluation of the data bracketed by percent of maximum VO_2 (VO_{2m}) was decidedly appropriate in determining whether the data could be extrapolated downward to reasonably simulate low energy-expenditure activities. Typically VO_2 reserve (VO_{2res}) is used; however, this was not measured in the Adams' studies. A tripartite categorization of the measured VO_2 for a step relative to the VO_{2m} of each subject was undertaken using <33.3%, 33.3-66.6%, >66.6% of VO_{2m} as the category boundary values. This categorization has been done previously based on intervals of low, moderate, and vigorous exercise and recently summarized from the exercise physiology literature (McCurdy and Graham, 2004). Residuals distributions were estimated using the multiple linear regression and mixed models as was done above [equations (3) and (4)], but now accounting for the tripartite categorization.

Residuals for the MLR model using equation (3) and the tripartite categorization (Table A-4) were generally lower at the lower and moderate level exercise levels compared with the estimated total residuals in Table A-3. This indicates there is less variability in ventilation rate at the low and moderate exercise levels.

Table A-4. Residual distributions standard deviation estimates (e_b and e_w) using data categorized by percentage of maximum VO_2 (VO_{2m}) assuming equation (3).

Age Group	<33.3% VO_{2m}			33.3-66.6% VO_{2m}			>66.6% VO_{2m}		
	e_i	x	n	e_i	x	s	e_i	x	s
<20	0.1233	123	2.0	0.1007	179	2.5	0.1523	137	2.8
20-<34	0.1486	127	1.9	0.1184	428	2.9	0.1734	521	4.1
34-<61	0.1954	74	1.8	0.1568	144	3.2	0.1592	139	3.5
61+	0.0974	9	1.9	0.1144	78	2.7	0.1344	67	3.4

- x is the number of subjects in given age group and tripartite categorization where measurements were collected.
 n is the average number of VO_2 samples subjects had within each age group and tripartite categorization.

For the mixed model, between-person residuals (e_b) were generally higher and the within-person variability was lower for all age groups using the tripartite breakdown (Table A-5) compared to the residuals distributions estimated using all of the data combined (Table A-3). This indicates that there is greater variability in ventilation between persons and less variability within a person than would be simulated when an individual is performing low-level activities. One may expect this to occur intuitively since the tripartite breakdown basically restricts the total number of measurements for an individual while the number of individuals for the most part has remained the same. There was a small difference in the total number of subjects in each exercise category because some of the individuals did not attain a level of exercise >66.6% VO_{2m} ; however, this was not the principal reason for the observed residual differences since consistently even fewer individuals were measured at exercise <33.3% VO_{2m} (Tables 4 and 5). In addition, more measurements were consistently obtained for exercise >66.6% VO_{2m} on average per person than at the low or moderate levels of exercise.

Table A-5. Residual distributions standard deviation estimates (e_b and e_w) using data categorized by percentage of maximum VO_2 (VO_{2m}) assuming equation (4).

Age Group	<33.3% VO_{2m}		33.3-66.6% VO_{2m}		>66.6% VO_{2m}	
	e_b	e_w	e_b	e_w	e_b	e_w
<20	0.1217	0.0506	0.0951	0.0456	0.1637	0.0741
20-<34	0.1291	0.0728	0.1088	0.0524	0.2190	0.0740
34-<61	0.1522	0.0938	0.1444	0.0581	0.1936	0.0710
61+	0.1244	0.0164	0.1112	0.0362	0.1422	0.0563

Numbers of individuals and samples collected per individual are the same as indicated in Table A-4.

These results in Tables A-4 and A-5 imply that activity-level specific equations may be warranted to better simulate an individual's ventilation rate over all ranges of exercise levels. However, given the sample size of the data set analyzed, further subclassification of the data would likely lead to greater instability of the regression coefficients and prevent reasonable

ventilation estimations for all exercise levels, age groups, or genders. Using the data provided in Table A-3 and implementation of either equation (3) or equation (4) should not have a large impact on a population-based exposure analyses.

It should be noted that in extrapolating lower than the age range of the original data (e.g., <3.6 years old), it is assumed that regression equations are suitable for these children and infants. The trend for VQ illustrated in Figure A-2 is likely to be continued upward for younger children and infants due to the anticipated reduction in efficiency (i.e., underdevelopment) of their respiratory systems. However, since the natural log for age <1 is negative [i.e., $\ln(1)=0$; for $x<1$, $\ln(x)<0$], the equations are inappropriate for infants <1.

Performance Evaluation

The algorithms underwent a probabilistic evaluation using either representative distributions of exposure model input parameters (evaluation method 1) and/or by using the algorithm in an actual exposure model (evaluation method 2). When simulating multiple activities for one individual and for a population, alternative sampling strategies are recommended below for estimating variability and uncertainty. Ventilation rates estimated using the general input parameter distributions (evaluation method 1) are summarized in Figure A-3 for females and males separately from using either the MLR or MER models.

Ventilation estimates for both the MLR and MER models are comparable to one another, particularly for young persons at each of the exertion levels and at the various mid to upper percentiles, however some trends were noted. Even though each simulation is independent, comparisons of the average percent difference at selected percentiles for each of the 5,000 person simulations are considered appropriate. Female ventilation rates estimated using the MLR tended to be slightly higher on average at each of the percentiles (average percent difference of between 3.5-4.0%) than those estimated using the MER for low exertion activities. This trend was also consistent with the results for males, whereas the MLR estimated ventilation rates were on average 1.6-2.9% higher than those estimated using the MER algorithm. Moderate exertion activities yielded the most similar results in both males and females (-0.6 to 0.1% and -0.1 to 0.9%, respectively). However, ventilation rates associated with vigorous activity levels were 1.3-1.8% lower in females, and 1.8-2.3% lower in males when comparing the MLR with the MER algorithm. These results suggest that either approach is acceptable for use in estimating ventilation rate, but that the MER model may be slightly more responsive to changes in activity level and better capture variability in ventilation rates, specifically when using the intra- and inter-personal residuals. Overall female ventilation rates ranged from 5 to 20 L/min, 20 to 50 L/min, and 40 to 100 L/min for low, moderate, and vigorous exertion activities, respectively using either algorithm. Ventilation rates for males ranged higher for the varying activities, with 10 to 35 L/min, 25 to 110 L/min, and 50 to 175 L/min estimated for low, moderate and vigorous exertion, respectively using either algorithm.

Additional evaluations were performed on the MER algorithm by estimating potential population-based ventilation rates with the APEX model. Results for the 20,000 person simulation of both genders are presented in Figure A-4. At any given percentile, ventilation rates increase rapidly with age for persons less than 20 years old, stabilize from ages 20 to about 60, then gradually decline with further increases in age. The distribution of these selected mid to upper percentiles for ventilation rate in individuals spans by about a factor of 5 or more,

depending primarily on age. Values at older ages are compressed, possibly biased by the small number of persons simulated (10-50 persons for each year in age 80 to 90; 1-10 for each year in age >90). Rarely did the upper percentile ventilation rate exceed 100 L/min, the majority of simulated persons performed activities requiring less than 50 L/min, with most breathing about 10 L/min throughout the day.

Results are also compared to those summarized by U.S. EPA (1997), but much of the data presented here are in fact approximations to that report utilizing similar approaches. Table 5-6 in U.S. EPA (1997) contains somewhat comparable data disaggregated by age and gender, adults only, for average inhalation rates. The origin of the U.S. EPA (1997) data, however, is Adams (1993), which is used extensively in this report. Recommended inhalation rates from Table 5-23 in U.S. EPA (1997), based on measured and approximated data, are presented in Table A-6 and are assumed to be reflective of "average" or likely inhalation rates and are generally comparable to the medians reported here in Figures 3 and 4.

Table A-6. Recommended inhalation rates (L/min) from U.S. EPA (1997) Table 5-23.

	Rest	Sedentary	Low	Medium	High
Children	5.0	6.7	16.7	20	31.7
Adults	6.7	8.3	16.7	26.7	53.3

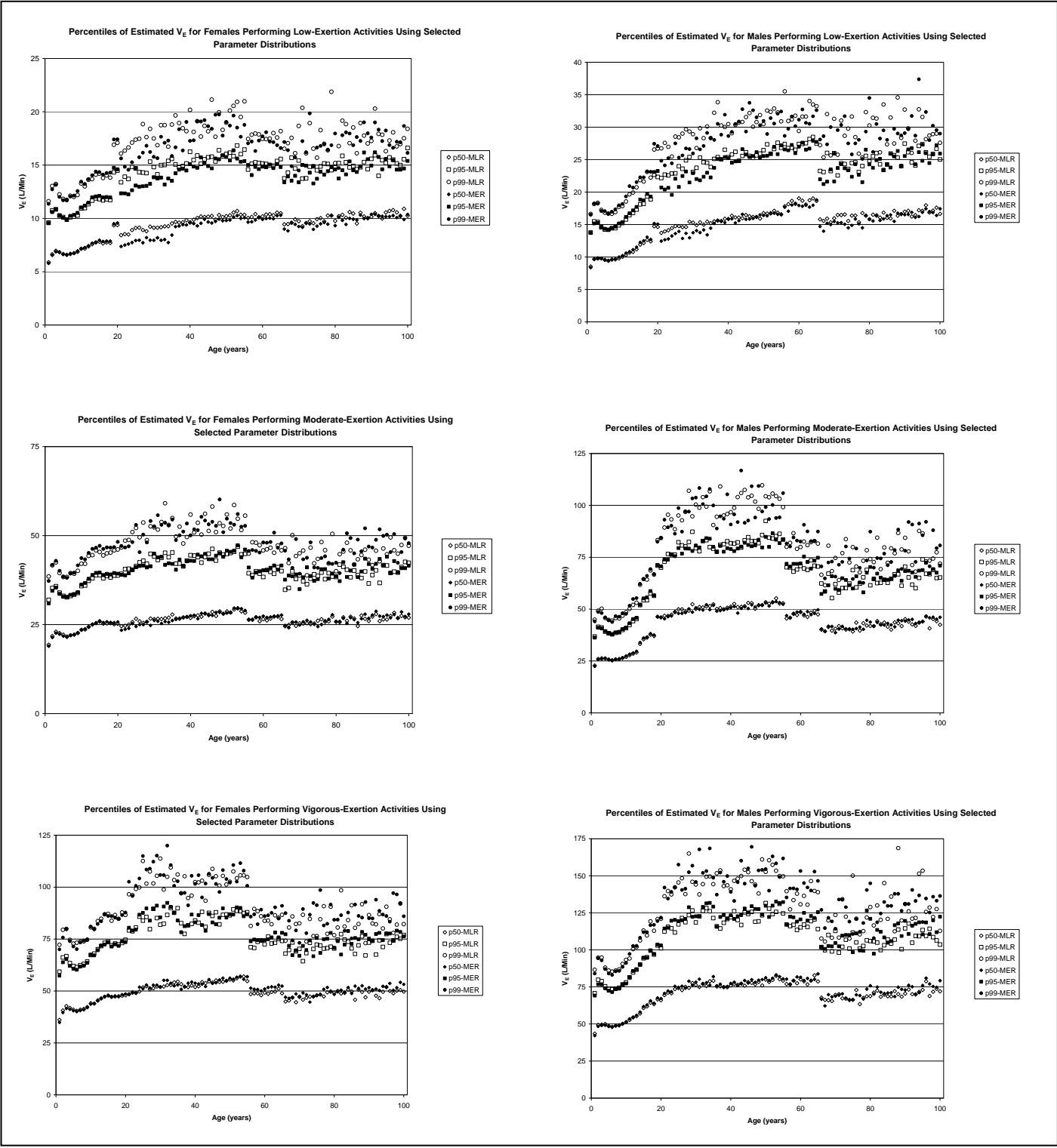

Figure A-3. Estimated ventilation rates (V_E , L/min) for females (left) and males (right) while performing low-level (top), moderate (middle), and vigorous (bottom) activities. Median (p50), 95th (p95) and 99th (p99) percentiles are given for a 5,000 person simulation for each of the multiple parameter regression models.

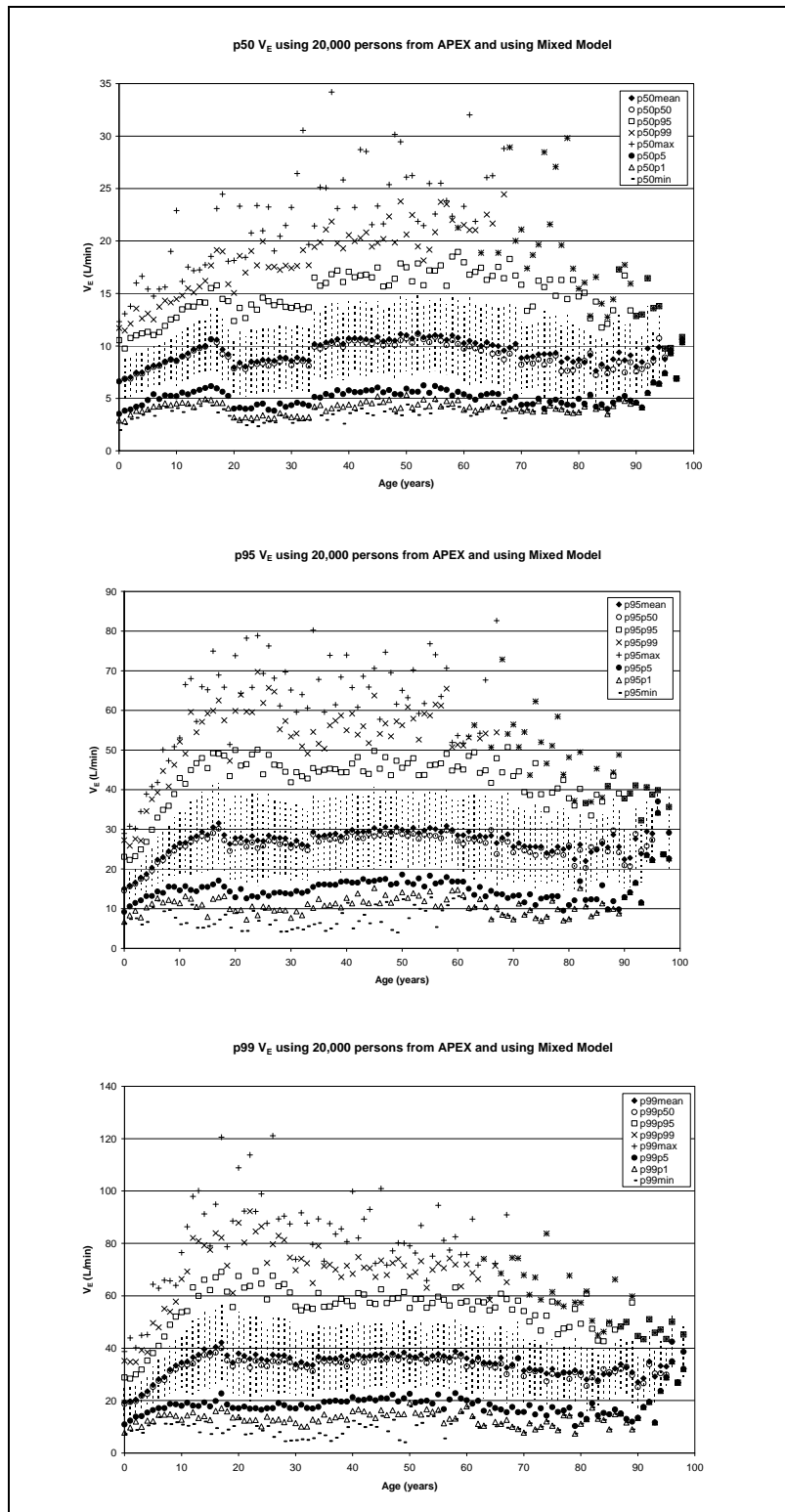

Figure A-4. Estimated population ventilation rates (V_E , L/min) for 20,000 persons using APEX and the mixed effects regression (MER) algorithm (Equation 4 and Table A-3). The full distribution of the median (p50-top), 95th (p95-middle) and 99th (p99-bottom) percentiles are represented for each age.

4. Recommendations

We recommend that for inhalation exposure modeling purposes, the regression equation coefficients listed in Table A-3 be used with equation (3) or (4) to estimate activity-specific body mass-adjusted V_E for simulated individuals in the age groups listed. Estimated regression coefficients and output from each of the algorithms were very similar, however gender within the MER algorithm was not considered statistically significant for the older age group compared with the MLR.

To obtain estimates of V_E in units of $L \text{ min}^{-1}$, the antilog of the predicted value multiplied by the subject's body mass (BM in kg) would be taken. Ages less than one year old are not to be approximated (i.e., persons with age < 1 can be estimated as one year old or using an alternative approximation). In addition, we suggest that individual variability be addressed by "fixing" the regression parameter estimates and using random sampling from each of the residual distributions $\{N: 0, \text{sd}\}$ to account for individual variability, with the MER model used when addressing inter- and intra-individual variability. Inter-individual variability is addressed through selection of between-person residuals (e_b) once per simulated individual. Intra-individual variability is addressed through selection of within-person residuals (e_w) every time an individual undertakes an activity. To address uncertainty, we recommend that additional simulations should be undertaken using the standard errors (se) of the regression coefficients themselves to address measurement error and unobserved variability.

5. Future Research

As mentioned earlier, a method for estimating V_A to remain consistent with the V_E estimation is currently being investigated by both NERL and OAQPS. Currently, the pathway from VO_2 to V_A is considered as a direct linear proportionality (i.e., a constant value of 19.63) and estimated independently from V_E . A preliminary literature review indicates that the approximation is reasonable and may be linear for low to moderate exercise levels, but at a minimum, there is variability in V_A at all exercise levels that is not accounted for by the point estimate used to modify VO_2 . Further investigation is needed to determine if the VO_2 to V_A relationship is maintained for vigorous activity levels. In addition, the lack of a direct computational link with V_E potentially can lead to simulated values of V_A in excess of V_E , a physiological impossibility.

One potential method would be to estimate V_A from V_E by using another physiological relationship: the ratio of dead space volume-to-tidal volume (V_D/V_T , see Figure A-1). Physiological dead space is the volume of the lung that does not take part in gas exchange and is comprised of basic anatomic dead space (e.g. volume of trachea and bronchioles) and areas of lung with reduced functionality (e.g., damaged alveolar regions, increased dead space due to bronchiole expansion during exercise). Tidal volume is the total amount of air breathed upon inspiration, not all of which comes in contact with the alveolar region of the lung due to the presence of physiologic dead space. It has been found that V_D/V_T does not remain constant over varying exercise levels, with V_T increasing at a greater rate than V_D during increasing exercise level. The effect of this non-linear relationship in simulating V_A (does V_A increase linearly with increasing VO_2 at all exercise levels?) has not yet been determined. The relationships of V_E ,

V_D/V_T , and VO_2 with V_A and other ventilation parameters (e.g., the respiratory quotient or RQ) will be explored in greater detail and integrated in a second report.

6. References

- Adams WC. 1993. Measurement of Breathing Rate and Volume in Routinely Performed Daily Activities. Davis CA: University of California.
- Adams WC, Shaffrath JD and Ollison WM. 1995. The relation of pulmonary ventilation and heart rate in leg work alone, arm work alone, and in combined arm and leg work. Paper WA-84A.04 presented at the Annual Meeting of the Air & Waste Management Assoc.
- Baba R, Mori E, et al. 2002. Simple exponential regression model to describe the relation between minute ventilation and oxygen uptake during incremental exercise. Nagoya J Med Sci. 65: 95-102.
- Burmaster DE and Crouch EAC. 1997. Lognormal distributions for body weight as a function of age for males and females in the United States, 1976-1980. Risk Anal. 17(4): 499-505.
- Galletti PM. 1959. Les échanges respiratoires pendant l'exercice musculaire. Helv Physiol Acta. 17:34-61.
- Johnson T. 1995. Recent advances in the estimation of population exposure to mobile source pollutants. J Exp Anal Environ Epidemiol. 5: 551-571.
- Johnson T. 2002. A Guide to Selected Algorithms, Distributions, and Databases Used in Exposure Models Developed by the Office of Air Quality Planning and Standards. Chapel Hill: TRJ Environmental.
- Johnson T and Adams WC. 1994. An algorithm for determining maximum sustainable ventilation rate according to gender, age, and exercise duration. Unpublished paper.
- Johnson T and Capel J. 2002. User's Guide: Software for Estimating Ventilation (Respiration) Rates for Use in Dosimetry Models. Chapel Hill NC: TRJ Environmental.
- Johnson T, Capel J, McCoy M, and Warnasch J. 1996. Estimation of Ozone Exposures Experienced by Outdoor Children in Nine Urban Areas Using a Probabilistic Version of NEM. Durham NC: IT Corporation.
- Johnson T and McCoy M. 1995. A Monte Carlo Approach to Generating Equivalent Ventilation Rates in Population Exposure Assessments. Washington DC: American Petroleum Institute (API Publication # 4617).
- Johnson T, McCoy Jr. M, and Ollison W. 1995. A Monte Carlo approach to generating equivalent ventilation rates in population exposure assessments." Paper 95-TA42.05 presented at the annual meeting of the Air & Manage. Waste Assoc.; San Antonio TX.

- Johnson T and Mihlan G. 1998. Analysis of clinical data provided by Dr. William Adams and revisions to proposed probabilistic algorithm for estimating ventilation rate in the 1998 version of pNEM/CO. Memo to A. Rosenbaum, Systems Applications International.
- Lin Y-S, Smith TJ, et al. 2001. Human physiologic factors in respiratory uptake of 1,3-butadiene. *Environ Health Perspect.* 109(9):921-926.
- McArdle WD, Katch FI, and Katch VL. 1991. *Exercise Physiology*. 3rd Ed. Philadelphia: Lea & Febiger.
- McCurdy T. 1994a. Human exposure to ambient ozone. pp. 85-127 in: D.J. McKee (ed.) *Tropospheric Ozone*. Ann Arbor MI: Lewis Publishers.
- McCurdy T. 1994b. Repackaging Adams (1993) breathing rate data. U.S. EPA memo, Research Triangle Park NC (April 20).
- McCurdy T. 1995. Estimating human exposure to selected motor vehicle pollutants using the NEM series of models: Lessons to be learned. *J Exp Anal Environ Epidemiol.* 5: 533-550.
- McCurdy T. 1997a. Comparison of cumulative inhaled ozone dose estimates using a disaggregated, sequential approach and alternative recommended approaches. Paper presented at the 7th Annual Meeting of the International Society of Exposure Analysis.
- McCurdy T. 1997b. Human activities that may lead to high inhaled intake doses in children aged 6-13. *Environ Tox Pharm.* 4: 251-260.
- McCurdy T. 1997c. Modeling the dose profile in human exposure assessments: ozone as an example. *Rev Tox: In Vivo Tox Risk Assess.* 1: 3-23.
- McCurdy T. 2000. Conceptual basis for multi-route intake dose modeling using an energy expenditure approach. *J Expos Anal Environ Epidemiol.* 10: 86-97.
- McCurdy T. 2001. *Research Note: Analyses to understand relationships among physiological parameters in children and adolescents aged 6-16*. RTP: U.S. Environmental Protection Agency (being reviewed).
- McCurdy T, Glen G, Smith L, and Lakkadi Y. 2000. The National Exposure Research Laboratory's Consolidated Human Activity Database. *J Exp Anal Environ Epidemiol.* 10: 566-578.
- McCurdy TR and Graham SE. 2004. Analyses to understand relationships among physiological parameters in children and adolescents aged 6-16. EPA/600/X-04/092.
- Nieman DC. 1999. *Exercise Testing and Prescription. A Health-Related Approach*. 4th edition. Mayfield Publishing Company, Mountain View, CA.

Schofield WN. 1985. Predicting basal metabolic rate, new standards and review of previous work. *Human Nutrition: Clinical Nutrition*. 39C(Supp1):5-41.

U.S. EPA. 1997. *Exposure Factors Handbook*. National Center for Environmental Assessment, Office of Research and Development, Washington D.C. EPA/600/P-95/002Fa.
<http://cfpub.epa.gov/ncea/cfm/recordisplay.cfm?deid=12464>

U.S. EPA. 2005. *Total Risk Integrated Methodology (TRIM) Air Pollutants Exposure Model Documentation (TRIM.Expo / APEX, Version 4) Volume I: User's Guide*. Office of Air Quality Planning and Standards, US EPA. November 2005.
<http://www.epa.gov/ttn/fera/data/apex/APEX4UG120505.pdf>

Attachment A1 to Appendix A

First memo from Dr. Adams to T. McCurdy describing major data set

21 August 1998

Dear Tom:

Enclosed is a diskette which includes the electronic data base containing data my graduate students and I have collected over the last 25 years on a large number of subjects of varying ages that includes VE, VO₂, and other physiological data that should be very useful for estimating VE and respiratory intake dose. It is in an Excel (5.0a) spread sheet format, as well as an ASCII format, blank delimited file with headings.

A description of the subjects for which data were potentially available was detailed in a list of 37 studies (pages 5-8) in my proposal dated 28 April 1998. Table A1-1 details the 31 studies for which valid physiologic data were available, together with the total number of subjects, their gender, and whether they were tested on a cycle ergometer or on a motor driven treadmill. Missing study numbers from the original proposal list denotes that no valid body composition and multi-stage VO₂max data were available. In Study 21, 16 male subjects exercised on a cycle ergometer (21.1), while 22 male subjects exercised on a treadmill (21.2).

The total number of subjects with multi-stage, steady-state corresponding VO₂ and V_E values, including those at VO₂max, was 521 males and 224 females. Most were obtained on a cycle ergometer test (262 males and 158 females), with the remainder on a treadmill, utilizing a walking and/or running protocol. In addition, steady-state VO₂ and V_E values at several submaximal workloads on the treadmill were available on 211 other subjects as described in Study 30, above. Time at each work level was usually two or three minutes, except at the maximal work level, which sometimes was as short as 15 sec. (with the physiologic data extrapolated to per minute values). A variety of progressive increment protocols were used on both the cycle ergometer and the treadmill. However, each (except for Study 30) was designed to obtain at least near steady-state physiologic response at progressively intensified work rates ranging from light, or moderate, through very heavy, ending with voluntary exhaustion.

In the electronic data base, the array of data for each subject is arranged horizontally in the following order:

1. study ID number (1=Study 1, 2=Study 2, etc.)
2. subject ID number
3. subject gender (0=male, 1=female)
4. subject age (years)
5. special characteristics of the subject (e.g., 1= trained athlete, 2= trained non-athlete, 3= normally active, 4= sedentary, and 5= obese)
6. subject height (cm)
7. subject body mass (kg)
8. subject lean body mass (kg)

9. machine used (1= cycle ergometer, 2= treadmill)
10. total test time (min)
11. observed VO_2max (l/min, STPD) for the test
12. for each step of the test for each subject, the following sequence was used:
 - a. cumulative test time at end of step
 - b. machine setting (cycle ergometer in Watts, treadmill in speed (m/min) and percent grade)
 - c. V_E (l/min BTPS) measured during the last minute of each step
 - d. VO_2 (l/min, STPD) measured during the last minute of each step
 - e. HR (b/min) measured during the last minute of each step

Table A1-1. Total subjects for each study, gender, and exercise ergometry used.

Study	Total Subjects	Males	Females	Cycle Ergometer Tests		Treadmill Tests	
				Males	Females	Males	Females
1	148	148	0	0	0	148	0
2	42	42	0	0	0	42	0
5	60	30	30	0	0	30	30
6	12	6	6	0	0	6	6
7	4	0	4	0	4	0	0
8	6	6	0	6	0	0	0
9	10	10	0	10	0	0	0
10	8	8	0	8	0	0	0
12	10	10	0	10	0	0	0
13	8	8	0	8	0	0	0
14	32	0	32	0	32	0	0
16	10	10	0	10	0	0	0
18	25	25	0	25	0	0	0
19	15	0	15	0	15	0	0
20	39	18	21	18	21	0	0
21.1	16	16	0	16	0	0	0
21.2	22	22	0	0	0	22	0
23	17	9	8	9	8	0	0
24	13	13	0	13	0	0	0
25	37	37	0	37	0	0	0
26	13	13	0	13	0	0	0
27	21	11	10	0	0	11	10
28	40	20	20	20	20	0	0
29	11	0	11	0	11	0	0
30	211	105	106	0	0	105	106
31	20	0	20	0	0	0	20
32	10	10	0	10	0	0	0
33	40	20	20	20	20	0	0
34	10	6	4	6	4	0	0
35	6	3	3	3	3	0	0
36	12	6	6	6	6	0	0
37	28	14	14	14	14	0	0
Total	956	626	330	262	158	364	172

Consistent units of measurement for all entries were used throughout the file. For machine setting, two columns were needed for treadmill tests, one each for speed and percent grade, while

only one (work rate in Watts) was required for Quinton electronically braked cycle ergometer tests. A Monark cycle ergometer was used in Studies 9 and 33-37. Calibration of the Monark device displayed on the ergometer itself only accounts for braking force produced by the flywheel friction strap, and does not include internal friction produced in the drive train. Therefore, work rate values displayed on the ergometer were converted to Watts and then increased by 9% in order to obtain corrected values (E. Harman, *Medicine and Science in Sports and Exercise* 21(4):487, 1989).

Quality assurance of the basic data, including that from handwritten records and computer print outs, was initiated by my review of each subject's data. Where apparent spurious data appeared, or notably aberrant subject responses were identified, they were eliminated from transfer to the electronic data base. I also noted any missing data for any subject, so that it was clear to the graduate student transferring the data which were valid and what data were missing. The graduate student transferring data to the electronic data base was thoroughly trained as to what data were to be entered and the format that they were to be entered in. After data were entered for a study, the graduate student read the data appearing on the original data record for each subject's protocol, while another graduate student verified that what was being said was what appeared on the spreadsheet. Errors identified by this procedure proved to be relatively small in number, non-systematic, and easily correctable. I have great confidence that the data furnished you are a valid representation of what appears in our original handwritten or computer print-out records.

A list of subjects who participated in more than one study is given below in ascending Study Number (and subject number) for the first study they participated in, and then the other study(ies), with their subject number(s), that they participated in.

Study 1

Subject #2 also subject #2 in study 2.
Subject #6 also subject #10 in study 18.
Subject #25 also subject #7 in study 2, and #3 in study 5.
Subject #29 also subject #18 in study 18.
Subject #30 also subject #23 in study 18.
Subject #43 also subject #3 in study 18.
Subject #52 also subject #2 in study 18.
Subject #54 also subject #17 in study 18.
Subject #55 also subject #20 in study 2.
Subject #56 also subject #19 in study 2, and #5 in study 19.
Subject #60 also subject #13 in study 2.
Subject #61 also subject #19 in study 18.
Subject #63 also subject #18 in study 2, and #5 in study 8.
Subject #69 also subject #16 in study 18.
Subject #88 also subject #21 in study 18.
Subject #89 also subject #14 in study 18.
Subject #91 also subject #22 in study 18.
Subject #97 also subject #11 in study 18.

Study 2

Subject #17 also subject #6 in study 18.
Subject #32 also subject #30 in study 5.
Subject #33 also subject #26 in study 5.
Subject #34 also subject #1 in study 8.
Subject #35 also subject #3 in study 8.

Study 5

Subject #18 also subject #1 in study 6.
Subject #19 also subject #3 in study 6.
Subject #21 also subject #6 in study 6, #1 in study 9, #1 in study 12, #2 in study 20, #17 in study 21.2, and #23 in study #25.
Subject #27 also subject #2 in study 9.
Subject #43 also subject #10 in study 6.
Subject #48 also subject #11 in study 6.

Study 9

Subject #9 also subject #15 in study 21.2.

Study 10

Subject #1 also subject #7 in study 13, #3 in study 20, and #34 in study 25.
Subject #2 also subject #4 in study 13 and #1 in study 20.
Subject #7 also subject #8 in study 13.

Study 12

Subject #10 also subject #5 in study 20.

Study 13

Subject #2 also subject #5 in study 16.

Study 20

Subject #7 also subject #16 in study 21.1 and #8 in study 25.

Study 21.1

Subject #3 also subject #3 in study 24 and #33 in study 25.

Study 21.2

Subject #18 also subject #18 in study 25.

Study 23

Subject #1 also subject #10 in study 28.
Subject #5 also subject #12 in study 24.

Study 24

Subject #13 also subject #21 in study 25.

Study 28

Subject #12 also subject #3 in study 32.

Subject #28 also subject #20 in study 31.

Study 31

Subject #10 also subject #40 in study 33.

Subject #15 also subject #3 in study 34.

Study 32

Subject #2 also subject #12 in study 33.

Study 33

Subject #3 also subject #7 in study 34.

Subject #7 also subject #4 in study 35.

Subject #9 also subject #10 in study 34, and #5 in study 35.

Subject #35 also subject #4 in study 34.

Study 34

Subject #1 also subject #2 in study 35.

Study 35

Subject #3 also subject #3 in study 36.

Study 36

Subject #12 also subject #26 in study 37.

I believe that this final report letter contains additional information beyond the electronic data base that you wanted and clarifies the format that was used. If you have questions, however, please do not hesitate to give me a call or drop me a note by FAX. I look forward to hearing from you and working with you and Ted on developing a publishable paper or two.

Best regards,

William C. Adams

Professor

Second memo from Dr. Adams to T. McCurdy describing additional data from study #30

8 October 2001

Dear Tom:

Pursuant to the U.S. EPA Order for Supplies and Services, No. 1D-5590-NATX, approved for the period, 1 August - 1 November 2001, I believe that I have now completed all professional services stipulated. Specifically, it was requested that I provide certain "raw" data on a group of children and adolescents who were part of the subject pool utilized in a California State Air Resources Board sponsored study, entitled: Measurement of Breathing Rate and Volume in Routinely Performed Daily Activities (Adams, 1993). The professional services stipulated included: 1) providing a complete listing of all variables that were obtained during the study in accordance with the attached Statement of Work; 2) the development of an electronic data base of selected physiological information for children and adolescents from the aforementioned study, again in accordance with the attached Statement of Work; and 3) the submittance of a transcribed data file for the aforementioned study in ASC II format, together with a description of data quality objectives that were established in accordance with the attached Statement of Work.

The subject pool of interest included 132 individuals, half female and half male, including 12 young children, age 3.6-5.8 yrs., 80 children, age 6.0-12.9 yrs., and 40 adolescents, age 13.2-18.9 yrs. All subjects were apparently healthy. In all cases, subject identification, including age and gender, as well as body weight, height, and activity habitus, were obtained. Body composition, as assessed by gender/age specific skinfold formulae, were used to calculate lean body mass. All subjects completed a laboratory treadmill walk (usually three different speeds, i.e., steps) and jog (ranging from 1 to 3 different speeds) protocol. The treadmill grade was horizontal throughout. Each subject completed a laboratory resting protocol (40 of the children did only sitting and standing, while the others also rested in a lying position). The 12 young children each did two spontaneous play protocols of 20 minutes duration, while 40 children also did two spontaneous play protocols, but of 30 minutes duration. The other 40 children did a single spontaneous play protocol of 35 minutes duration. The 40 adolescent subjects were not asked to perform a spontaneous play protocol. In addition, each subject (or their parent/guardian) completed an 11-item health history questionnaire.

Enclosed is a 3.75 ZIP disk which includes the electronic data base containing data described in general above. It is in an Excel (5.0a) spread sheet format produced on a Macintosh Performa 6214CD hard drive, as well as an ASCII format, blank delimited file with headings. Consistent units of measurement for all entries were used throughout this file. In the electronic data base, the array of data for each subject is separated into five distinct files: 1) active (treadmill) protocol; 2) resting protocol; 3) spontaneous play protocol; 4) health history responses to selected questions; and 5) predicted VO_{2max} values from measured submaximal HR and VO_2 values contained in File #1. Details of what items, variables, time periods, etc., and their order, which are arranged horizontally in each file, is as we agreed on via my FAX of 22 August 2001,

with minor modifications we agreed on by phone the next day. The order for each file is given below:

ACTIVE (File #1)

1. File ID number (#1)
2. subject ID number (same number for each subject as identified for Study #30 in 1998 data base)
3. subject gender (0=male, 1=female)
4. subject age (years)
5. special characteristics of the subject (viz., 1= trained athlete, 2= trained non-athlete, 3= normally active, 4= sedentary, and 5= obese)
6. subject height (cm)
7. subject body mass (kg)
8. subject lean body mass (kg)
9. machine used (1= cycle ergometer, 2= treadmill) - **NOTE: TREADMILL ONLY USED IN THIS STUDY.**
10. total test time (min)
11. observed VO_{2max} (l/min, STPD) for the test - **NOTE: VO_{2max} NOT MEASURED IN THIS STUDY.**
12. for each step of the test for each subject, the following sequence was used:
 - a. cumulative test time at end of step
 - b. machine setting (two columns: one for treadmill in speed (m/min) and one for percent grade). The latter was always zero.
 - c. V_E (l/min BTPS) measured during the last two minutes of each step
 - d. VO_2 (l/min, STPD) measured during the last two minutes of each step
 - e. HR (b/min) measured during the last two minutes of each step

RESTING (File #2)

1. File ID number (#2)
2. subject ID number (same number for each subject as identified for Study #30 in 1998 data base)
3. subject's body surface area in square meters; from measured body height and body mass, using the standard DuBois and DuBois formula
4. for each resting posture for each subject, the following sequence was used:
 - a. V_E (l/min BTPS) measured during the 5 minutes of each test
 - b. VO_2 (l/min, STPD) measured for the 5 minute of the test
 - c. average of five HR (b/min) measurements taken each minute of the 5 minute test
 - d. average of five breathing frequency (breaths/min) measurements taken each minute of the 5 minute test

SPONTANEOUS PLAY (File #3)

1. File ID number (#3)
2. subject ID number (same number for each subject as identified for Study #30 in 1998 data base)

3. for each 5 minutes data collection period for each subject, the following sequence was used:
 - a. V_E (l/min BTPS) measured during the 5 minutes
 - b. average of five HR (b/min) measurements taken each minute of the 5 minute period
 - c. average of five breathing frequency (breaths/min) measurements taken each minute of the 5 minute period. NOTE: Because these data were obtained on a tape cassette that rather routinely malfunctioned, valid data were obtained in only ~75% of the subject 5-minute time periods
 - d. activity intensity rating by the technician. NOTE: There was some confusion among the technicians as to what they were to indicate in the comments column; e.g., any problems with the equipment, what the subject was playing, and/or an estimation of the intensity of activity. The occasional noted problems with equipment were dealt with as described on pp. 38-39 of the CARB Final Report (Adams, 1993). While the play activity was occasionally recorded, it was not systematic (i.e., estimated at between 15-20%). Intensity of play was recorded ~55% of the time. The intensity scale devised and used for the first time in the enclosed data base was: 1 = standing, or just "hanging out"; 2 = moderate intensity, i.e., walking, swinging an implement, kicking or throwing a ball, etc.; and 3 = vigorous, or very active. Ratings of 1.5 and 2.5 were used to indicate activity intensity somewhere in-between the absolute number categories. The mean value for each 5-minute period was near 2.0, moderate, which closely agrees with the observed V_E estimated intensity discussed on p. 110 of the CARB Final Report.

HEALTH HISTORY (File #4)

1. File ID number (#4)
2. subject ID number (same number for each subject as identified for Study #30 in 1998 data base)
3. Re question #1, how often do you exercise? Numerals in column 3 correspond to which of 5 choices were circled.
4. Re question #2, describe the intensity of your exercise. Numerals in column 4 correspond to which of 5 choices were circled. In six cases, two adjoining numbers (e.g., 2 and 3) were circled, and the mean entered (in this case, 2.5).
5. Re question #3, what types of exercise do you engage in? Numerals in column 5 correspond to which of 9 choices were circled. No one circled No. 1 (none). Most subjects circled more than one choice, which is reflected by the numerals 2 through 8 in column 5 for each subject. If the subject circled 9 (other), the following numerals were entered in column 5 to indicate which other activities they engaged in (10, play; 11, dance; 12, horseback riding; 13, gymnastics; 14, rollerblading; 15, karate; 16, ice skating; 17, aerobics (high impact); 18, aerobics (machines at fitness club); 19, hockey; and 20, boxing)
6. Re question #7, any medical complaints? 1 = yes; 2 = no. If yes, 1 was not entered, but what "caused" the yes answer was entered in column 6 as follows: 3, asthma; 4, ear, 5, scoliosis; 6, cerebral palsy; 7, allergies

7. Re question #11, do you have, or have you ever had, any of the following? Numerals from 1 through 12 in column 7 indicate that only one choice was circled. If more than one choice was indicated, higher numbers were used as follows: 13, choices 7, 9, and 10; 14, choices 9, 10, and 11; and 15, choices 10 and 11.

PREDICTION OF VO_{2MAX} FROM SUBMAXIMAL MEASURED HR AND VO_2 VALUES OBTAINED FROM FILE #1 (File #5)

1. File ID number (#5)
2. subject ID number (same number for each subject as identified for Study #30 in 1998 data base)
3. subject body mass (kg)
4. subject age (years)
5. estimated HR_{max}
6. VO_{2max} y intercept
7. VO_{2max} b exponent
8. predicted VO_{2max} (l/min)
9. predicted VO_{2max} (l/min/kgBM)

The rationale for predicting percent VO_{2max} at any given percent HR_{max} is developed in brief on p. 403 of McArdle et al.'s exercise physiology text (4th ed., 1996) and in more detail in Astrand and Rodahl's Textbook of Work Physiology (2nd ed., 1977), pp. 344-348. Using data from both sources, I calculated very closely similar submaximal % VO_{2max} values as a function of % HR_{max} values (i.e., never more than 2%, and usually the same or only 1% difference). To get a clear visual perspective overview of the estimated VO_{2max} prediction from measured submaximal HR and VO_2 , see Fig.10-4 (line A), p. 346, in Astrand and Rodahl. To use this procedure, it is first necessary to obtain a valid HR_{max} value which decreases an average of 1 b/min each year of age from 10 years on. The best data I'm aware of on young children and adolescents that had HR and VO_2 measured in both submaximal and maximal treadmill exercise is that of Astrand (Experimental Studies of Physical Working Capacity in Relation to Sex and Age, 1952, Ejnar Munksgaard, Copenhagen). Between the ages of 4 and 10 years, there was no significant relationship between HR_{max} and age for either sex, averaging 205 b/min. Thereafter, up to 33 years, there was the now widely accepted decrease of 1 b/min per year of age for both males and females, with 10 year-old boys and girls averaging 210 b/min. Accordingly, in File #5, the estimated HR_{max} in column 5 is 205 b/min for subjects less than 10 years of age and 220 minus age in years for subjects 10 to 18.9 years of age. The y intercept and b exponent values for predicting VO_{2max} were obtained by calculating, via simple regression analyses, individual subject values from measured submaximal HR and VO_2 values taken from File #1. Predicted VO_{2max} (in l/min), given in column 8 for each subject, was obtained by multiplying the b exponent value (column 7) times the estimated HR_{max} value (column 5) for each subject, and then subtracting their y intercept value (column 6). Each subject's VO_{2max} value in ml/min/kg (column 9) was calculated by dividing the column 8 value by body mass (column 3).

Accuracy of the data in the enclosed electronic files began with data management and quality control procedures employed in the original CARB study, and which are described in detail on pages 38-39 of the Final Report (Adams, 1993). In summary, very few problems were encountered in the acquisition of active and resting protocol data. Accuracy assurance procedures for the transfer of the data from handwritten records to master data sheets, and

subsequently to electronic spreadsheet data bases, is described in the aforementioned Final Report. The retrospective quality control program for all field protocol data bases, including spontaneous play, revealed that 5 children needed to repeat a protocol. Elimination of aberrant bits of data obtained during the play protocols (due to the result of momentary saliva blockage in the Harvard respirometer, Heart Watch heart rate artifacts, etc.), which rarely included more than one or two 1-min "glitches" in any one protocol, were part of the aforementioned quality control program. When this was done, the remaining data for the 5-min period was used to calculate an average for the full time period (i.e., 20, 30, or 35 min). A significant number of play protocols (~35%) were completed with incomplete, or no, f_B data. This occurred because there was no way to determine whether the expiration electronic pulse from the Harvard respirometer was being recorded on the tape cassette until after the protocol was completed. However, since these were random occurrences, and f_B was not of such prime concern as HR and V_E , these protocols were not repeated.

Per the Statement of Work for this project, to ensure that an accurate translation of the data was accomplished, all data entries were checked by me. The data quality objectives described in detail below were developed before data were translated to the enclosed electronic data files. These objectives were applied against 100% of the entries transcribed, including file column headings, for the first 500 datum points. In each of the five files, this objective was met, and double-checking procedures described in detail below were employed to achieve the highest accuracy possible. I have great confidence that the data furnished you are a valid representation of what appears in our original CARB study computer data files and the original handwritten records used to transfer data to electronic files for the first time in this project.

The specific procedures used for each of the five files differed somewhat and are described in detail here. For the active file, a copy of the 1998 Excel file was made and all data not from Study #30 for the 132 subjects of interest were deleted. A search of the original 1998 Excel file was done, and a print out of these data obtained (i.e., pp. 14-18, 36-40, 58-62, and 80-84). All entries in the 2001 file were double-checked against the 1998 print-out for the first 12 subjects, and for subjects 13, 45, 46, 58, 59, 66, 107, 131, 132, 150, 151, and 152. Finally, the values on the last page of data for all subjects was verified. In no case was any difference seen.

Formulation of the file for the resting protocol (#2) was initiated by transferring data from summary CARB study electronic data files (in a similar, but not exact format for each subject) to the present electronic data file. Individual data values for all variables in each posture were double-checked against a print-out of the 1998 data for the first 12 subjects, and for every 10 subjects thereafter. In no case was any difference seen. As a further cross-check, I then calculated entire group ($N = 132$) means for each posture in the present file, and compared these values to weighted tabular mean values in the original Final Report, and found no difference greater than 0.7%, i.e., within the range of rounding error.

Formulation of the file for the play protocol (#3) entailed entering V_E , HR, and breathing frequency data from handwritten data summary sheets. All values were double-checked immediately after entry for each time period (4 to 7) for each subject ($N=92$). In addition, I then calculated an entire group mean for each time period, and compared these values to weighted tabular mean values in the original Final Report. Again, I found very close agreement. Intensity

values available for each time period for each subject were entered from handwritten data acquisition sheets into the electronic data base (File #3). As I entered them, I double-checked these values against that read from the data sheet, and that the adjacent HR and breathing frequency data were for the correct subject and time period.

Procedures used for establishing the health history data base from handwritten responses to a questionnaire, together with how data was entered in each column, are described above. The data were typed directly into the electronic file (#4) for each subject from the handwritten responses on the questionnaire. The numerical values entered were double-checked for each question (#s 1, 2, 3, 7, and 11) for each subject immediately after each subject's data entry.

Procedures used for predicting each subject's VO_{2max} from submaximal HR and VO_2 data (the latter obtained from File #1), together with how data was entered in each column, are described above. The data for columns 1-4 were transferred directly from File #1 and a mean, with standard deviation, calculated for each column which matched those previously calculated in File #1. The individual submaximal HR and VO_2 values entered into a STATVIEW simple regression analysis were each double-checked before each individual analysis was done. The resultant y intercept and b exponent values were written on a printout of the subjects' submaximal HR and VO_2 values, with each set double-checked as they were entered in the File #5 Excel spread sheet. In addition to recalculating all values for the first 10 subjects, any subject who had a predicted VO_{2max} value < 33 or > 66 ml/min/kg was double-checked. In no case was an error found. Please note that 18 subjects only had 3 sets of submaximal values (i.e., all at three walking speeds). In all but 4 cases (subjects # 3, 29, 108, and 142), the spread of observed HR and VO_2 values was sufficient (in my estimation) to obtain valid predicted VO_{2max} values. Thus, I recommend deleting the predicted VO_{2max} values for these four subjects. If this is done, the mean VO_{2max} for the group is 47.63 ml/min/kg, a value that I consider highly likely in a group of healthy children and adolescents of probable slightly greater fitness than the average population.

I believe that this final report letter contains additional information beyond the electronic data base that you wanted and clarifies the format and procedure that were used. If you have questions, however, please do not hesitate to give me a call or drop me a note by FAX. I look forward to hearing from you and working again with you in the future.

Best regards,

William C. Adams, Ph.D.

Attachment A2 to Appendix A

Data Set Manipulation. The data file needed significant manipulation to facilitate statistical analysis. Principally, the row and column structure of the file had to be altered to put them into proper alignment. Row headings were scattered within rows of the data set due to two different test protocols (cycle and treadmill) that required different parameter measurements. In addition, within-person measurements for the same parameter (e.g., total ventilation or V_E) over multiple stages of the test (V_{E1} , V_{E2} , V_{E3} , etc.) were carried across the dataset in multiple columns. It was desired to have the multiple measurements as a single vector for a given parameter. Therefore, the following changes were made to the data set:

- 11 separate data sets were created in Excel by the 11 heading groupings within the raw data set (more than one study could be combined under previous headers)
- A master list of parameters was created such that the 11 data sets could be combined under one heading having 102 unique designations. Specific changes made were:
 - Parameter heading for step 14 was removed since there were no parameters supplied for this step (e.g. V_{E14} , $VO_{2\ 14}$, etc.).
 - Common data were recoded into vectors having a common descriptor. Originally identical names were not used to describe the same parameter at different steps (e.g., the speed parameter for the cycle ergometer used “spd” for steps under 10 (e.g., spd1) and “sp” for steps >9 (e.g., sp13). It was assumed that “sp”=“spd”, and for grade, “gr”=“grd”).
 - Removed inconsistent coding. Spd12 on one instance was mislabeled as Spd11 in Study #1. This was corrected.
 - Cleaned up variable name conventions. Both “Age” and “LBM” parameters contained a space after the label characters. This space was removed.
- These 11 Excel data sets were combined in SAS to create a SAS data set (adams.sas7dbat).
- In SAS, multiple measurements for a parameter (e.g., V_{E1} , V_{E2} , V_{E3} , etc.) were combined under a single vector (e.g., V_E) to create a second SAS data file: adams2.sas7dbat. A new variable was created to account for the multiple measurements for a given parameter termed ‘step’ (e.g., step=1 is for where V_E and VO_2 were first recorded; step=2 for the second measurement of V_E , etc.).
- This data set contained a total of 19 variables:
 - Step Step or stage measurement taken within an individual
 - Age Subjects age in years (yrs)
 - BM Body mass (kg)
 - Char A characteristic of an individual acting as a surrogate for fitness level
 - 1= Trained athlete
 - 2= Trained non-athlete
 - 3= Active individual
 - 4= Sedentary individual
 - 5= Obese
 - ET Cumulative test time at the end of each step (min)
 - Gend Gender: ♂ = -1; ♀ = 1

- Grd Grade on treadmill (in percent)
- HR Heart rate (bpm or beats min⁻¹)
- HT Height (cm)
- LBM Lean body mass (kg)
- Mach Machine used: Cycle Ergometer = 1; Treadmill = 2
- VO2 VO₂ (L min⁻¹ BTPS)
- Spd Speed of the Subject on Treadmill (m min⁻¹)
- stud Study number
- Subj Subject number
- TT Total test time (min)
- VE V_E (L min⁻¹)
- VO_{2m} Observed or estimated VO₂ maximum for the test (L min⁻¹ STPD)
- Wk Watts (power setting for the cycle ergometer)

Maximum VO₂ (VO_{2m}) was reported for all of the studies but one. Study 30 contained estimates of VO_{2m} for some of the data (individuals < 18.9 years old) however the study also contained 79 individuals where VO_{2m} was neither measured nor estimated. The method reported by Adams (see Appendix B) to estimate VO_{2m} for the younger individuals was duplicated here for the missing data. Briefly, maximum heart rate (HR_m) was estimated using an equation provided in Nieman (1999) (i.e., HR_m=220-age). A simple linear regression analysis followed for each individual (of the form $y=mx+b$) where HR measurements were regressed on concomitant VO₂. The slope (m) and intercept (b) estimates were then used to approximate VO_{2m} from the HR_m estimate and added to the final data set.

Quality Assurance. Data values--mostly V_E, VO₂, and BM, since these were the principal analytical parameters-- were spot-checked by hand from the original Excel spreadsheet to both newly created SAS data sets. No errors were found in either of the SAS data sets. The number of individuals in the newly created data sets was each 956, equivalent to that reported by Dr. Adams upon transfer of the data set (in Appendix A) and the total number of measurements of V_E and VO₂ for individuals >18 years old was equivalent (n=5,681) to that reported by Johnson (2002).

A simple plot of the body mass-normalized total ventilation versus the body mass-normalized oxygen consumption revealed that two individuals (i.e., stud=1 subj=25 step=8; stud=31 subj=9 step=8) had exceptionally large oxygen consumption levels during one sample collection. These data were considered to be questionable, and upon inspection seemed to be the result of a misplaced decimal point (30.8 and 28.5 should be 3.08 and 2.85, respectively).

Data were replaced in the SAS data sets to reflect this assumption rather than delete the datapoints altogether, even though there is no direct evidence that the decimal was misplaced. Due to the number of samples for a given parameter in the data set (>5,000), the impact of this change on the analyses presented here is negligible. The new dataset was saved as 'adams3.sas7dbat' (from data set 'adams.sas7dbat') and 'adams4.sas7dbat' (from data set 'adams2.sas7dbat').

Data Transformation. Figure A2-1 shows the relationship between total ventilation and oxygen consumption rates. In general, the relationship is non-linear and exhibits greater variability among individuals at higher oxygen consumption rates (i.e., the data are heteroscedastic), similar to findings of other researchers (e.g., Baba et al. 2002). Normalization of V_E and VO_2 by body mass is commonly done to account for a portion of the variability inherent between the two physiological measures (Figure A2-2).

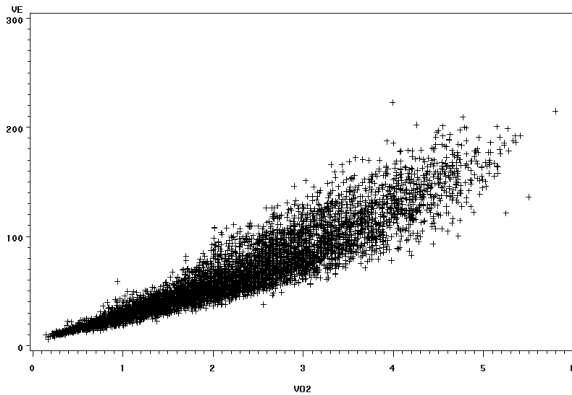

Figure A2-1. Relationship between total ventilation rate (V_E) and oxygen consumption rate (VO_2) during exercise.

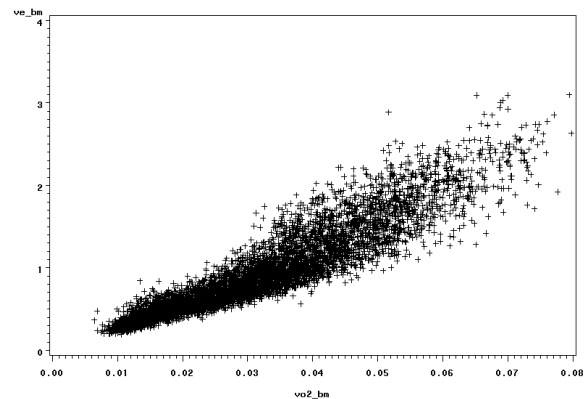

Figure A2-2. Relationship between body mass normalized total ventilation rate (V_E/BM) to oxygen consumption rate (VO_2/BM) during exercise.

Due to the non-linear relationship between V_E and VO_2 , a number of the parameters were transformed by taking the natural logarithm (Ln) of the variable. These include:

- $\text{Ln}(V_E)$ natural log of V_E
- $\text{Ln}(VO_2)$ natural log of VO_2
- $\text{Ln}(V_E/BM)$ natural log of body mass normalized V_E
- $\text{Ln}(VO_2/BM)$ natural log of body mass normalized VO_2
- VQ ventilatory equivalent or V_E / VO_2
- $\text{Ln}(\text{age})$ natural log of age

A logarithmic transformation directly applied to the parameters allows for a significant reduction in the dispersion (Figure A2-3 compared to Figure A2-1), and when used in combination with body mass normalization, yields a mostly linear relationship having a more balanced dispersion across the range of oxygen consumption rates (Figure A2-4), that is, it better demonstrates a degree of homoscedasticity. It should be noted that this linearity and balanced dispersion was also demonstrated among different age groups investigated in the body of the report.

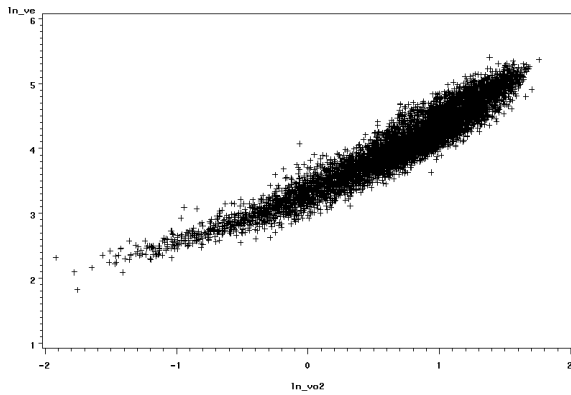

Figure A2-3. Relationship between the natural logarithm of total ventilation rate $\text{Ln}(V_E)$ and oxygen consumption rate $\text{Ln}(V_{O_2})$ during exercise.

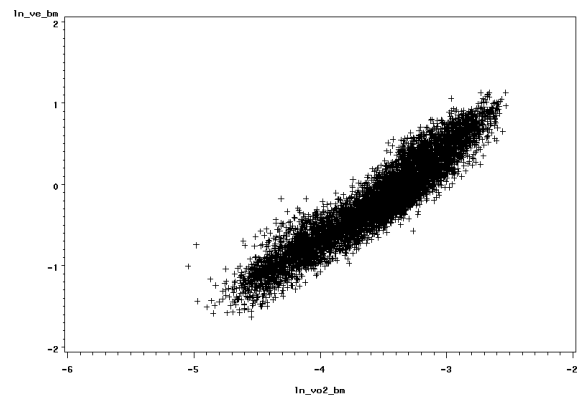

Figure A2-4. Relationship between the natural logarithm of body mass normalized total ventilation rate $\text{Ln}(V_E/\text{BM})$ and oxygen consumption rate $\text{Ln}(V_{O_2}/\text{BM})$ during exercise.

Attachment A3 to Appendix A

Selected ventilation algorithms were evaluated using the APEX model by adjusting the ventilation.txt file (see U.S. EPA, 2005). 20,000 persons were simulated for one day using the algorithms described in the main body text and parameters in Tables 2 and 3. Model output was nearly 800,000 event-based ventilation rates, typically around 40 events per individual simulated. Figure A3-1 presents the mid to upper range percentiles based on these 800,000 events to encompass the possible maximum ventilation rates generated by each simulation. Algorithms evaluated included the following:

MLR: multiple linear regression algorithm using equation 3 and parameters from Table A-3.

MER: mixed-effects regression model using equation 4 and parameters from Table A-3.

MLR+MER: regression coefficients from MLR coupled with variance components estimated from the MER model.

Johnson: Johnson (2002) regression model using equation 2 and parameters from Table A-2.

SMER: a simplified mixed effects regression model using equation 2 and parameters derived for all age groups from the Adams data set as follows:

	<u>Ln(VO₂/BM)</u>		<u>Residuals</u>	
	b₀	b₁	e_b	e_w
Females	4.1017	1.1904	0.1408	0.1186
Males	3.9332	1.1638	0.1445	0.1277

Results are very similar for each of the algorithms, not surprisingly since they were for the most part derived from the same data set. At any given percentile, ventilation rates increase rapidly with age for those less than 20 years old, stabilize from ages 20 to about 60, then gradually decline with further increases in age. Increased variability at ages greater than 75 is also evident, a function of both the limited amount of data available for the development of the algorithm and the limited number of persons simulated at these ages from the population of 20,000. At each of the percentiles, the Johnson (2002) algorithm generated lower ventilation estimates for persons under age 5, a function of the method of the algorithm derivation, whereas the intercept was modified based on published literature VE/VO₂ relationships while the residuals were assumed the same as those greater than 18 years of age. When considering a simple mixed effects regression (SMER) algorithm, flattening out of the percentiles occurs across the ages, mostly due to elevation of ventilation rates of young children that resulted from ignoring age as an independent variable in development of the regression parameters.

Figure A3-2 presents the full range of percentiles for the event-based ventilation rates generated from the APEX model using the mixed effects regression (MER) model and the Johnson (2002) model. Results are very similar, however at young ages (<5 years old), the Johnson (2002) model estimates lower ventilation rates at both the lower and upper percentiles. The percent difference between the two model estimates is large, ranging from about 40-120% lower (Figure A3-3). The lower percentiles (min, p1, p5) for all ages >5 are moderately different, the Johnson (2002) ventilation estimates are less than the MER by about 20-40% for ages 10-45, then 10-

20% greater than the MER estimates for ages above 45. The MER algorithm estimates higher ventilation rates for persons above age 60 by about 20% considering the upper percentiles (p95, p99, max), with greater differences at age 90 and older (20-60%).

Figure A3-1. Comparison of selected percentiles of estimated event-based ventilation rates from 20,000 person APEX model simulation using different ventilation algorithms.

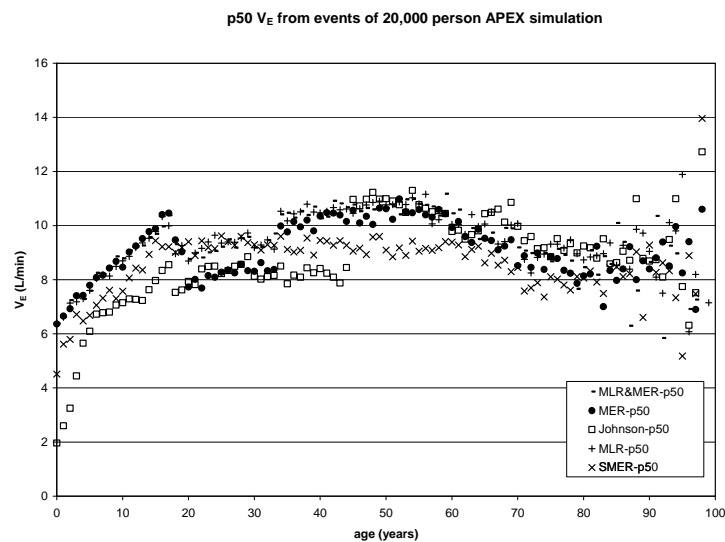
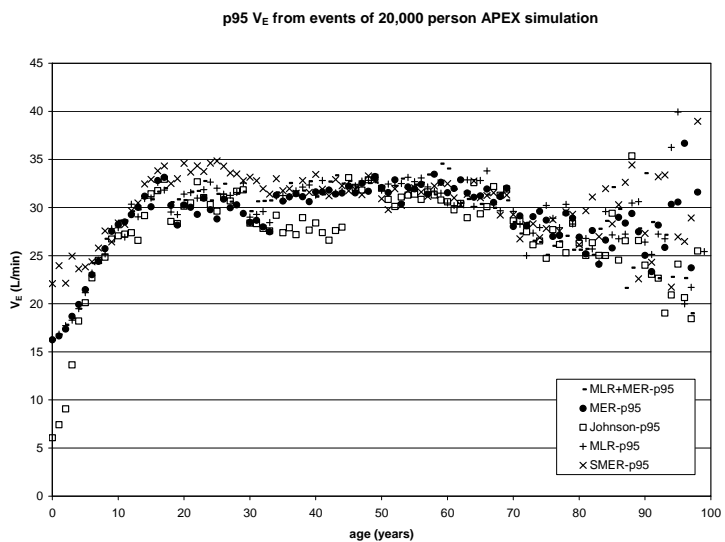
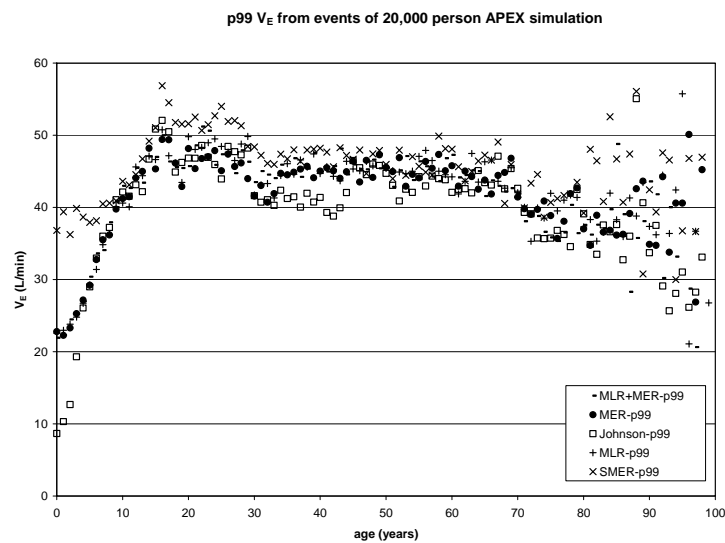
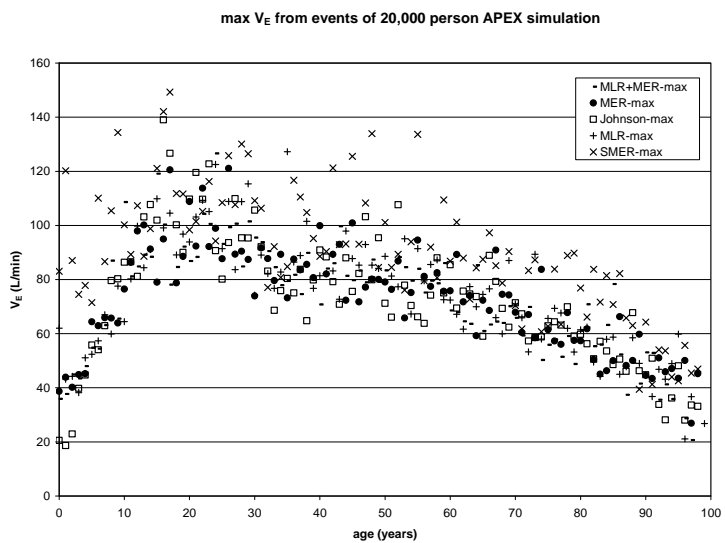
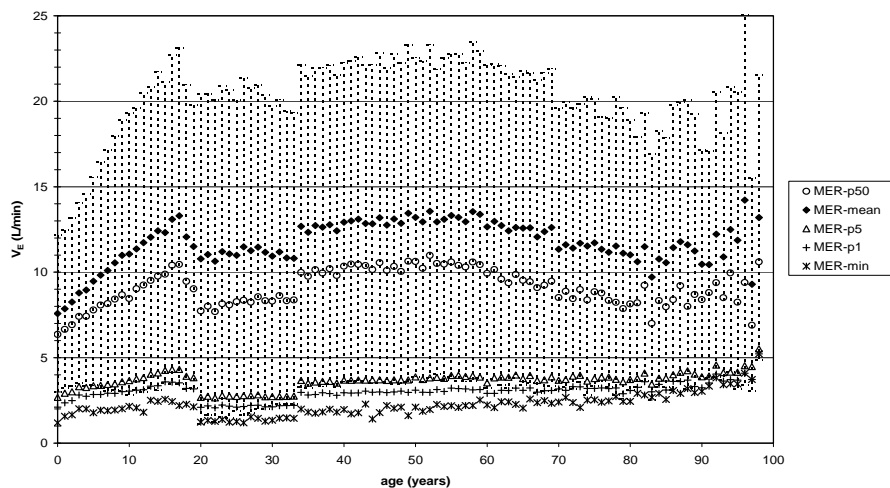
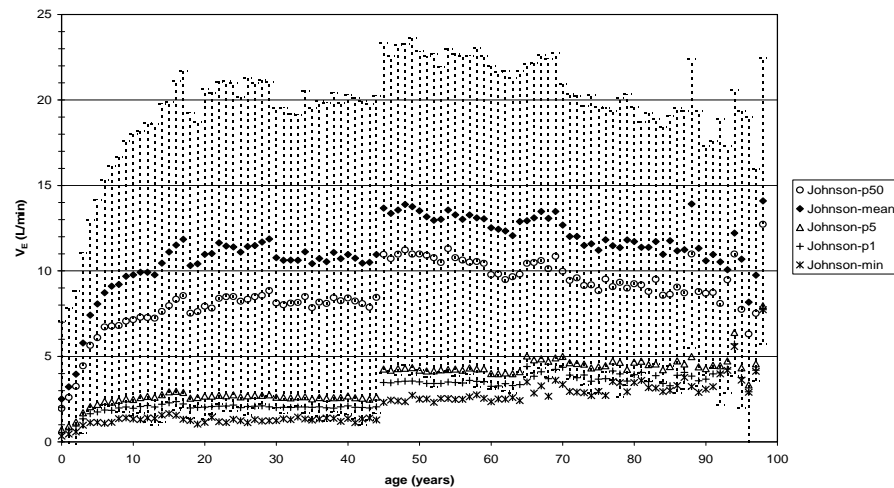

Figure A3-2. Comparison of estimated event-based ventilation rate percentiles from 20,000 person APEX model simulation using mixed effects regression (MER-left) and Johnson (2002) (right) ventilation algorithms.

Mixed Model Estimates of V_E from for 796,714 events from 20,000 person APEX simulation
Lower Percentiles



Johnson Model Estimates of V_E from for 799,355 events from 20,000 person APEX simulation
Lower Percentiles



Mixed Model Estimates of V_E from for 796,714 events from 20,000 person APEX simulation
Upper Percentiles

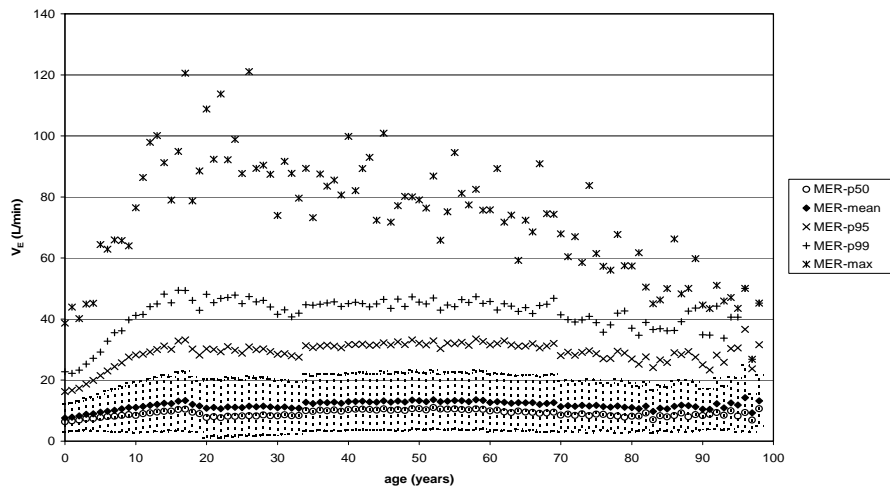

Johnson Model Estimates of V_E from for 799,355 events from 20,000 person APEX simulation
Upper Percentiles

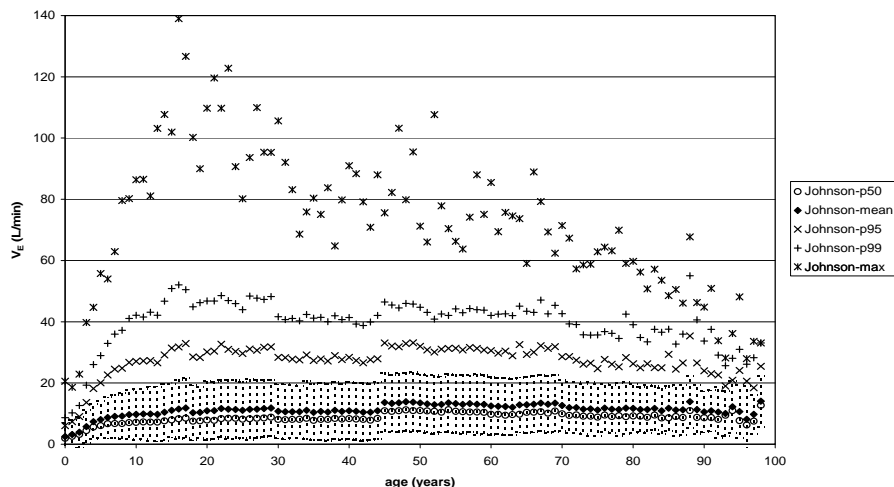
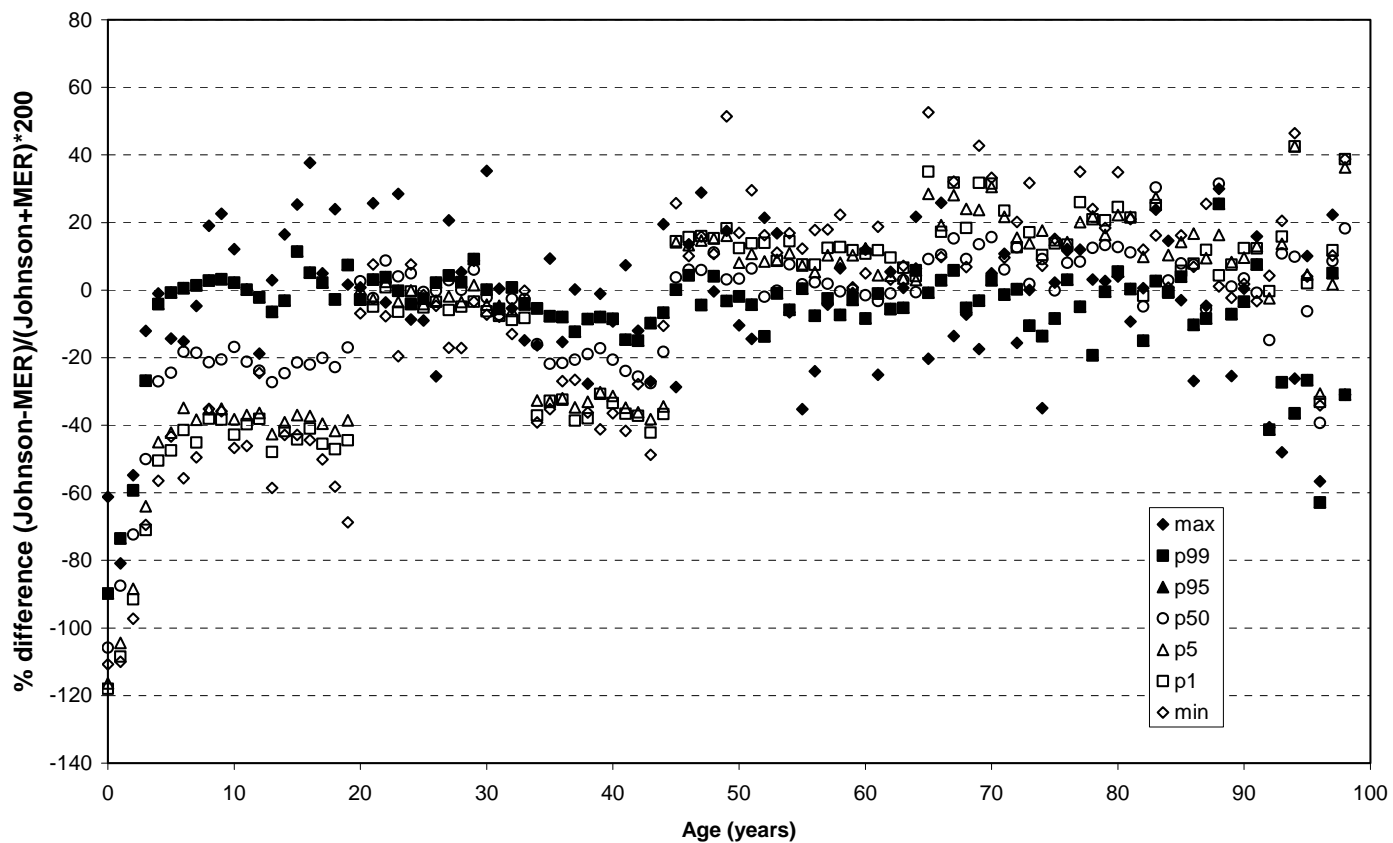

Figure A3-3. Percent difference of estimated event-based ventilation rate percentiles from 20,000 person APEX model simulation using mixed effects regression (MER-left) and Johnson (2002) (right) ventilation algorithms.



APPENDIX B

STATISTICAL DISTRIBUTIONS ASSIGNED TO ACTIVITY CODES FOR USE IN SIMULATING METS VALUES

LIST OF TABLES

B-1. METS Distributions assigned to activity ID codes within CHADB-4

B-2. Activity codes whose METS Distributions were assigned to those codes
encountered in the NHAPS Database but having no METS Distribution assigned
by CHADB-11

Table B-1 documents the activity ID codes included in the CHAD, along with the statistical distributions underlying the METS values that CHAD has assigned to each code. These distributions have been documented in Appendix 1 of the CHAD User's Guide (U.S. EPA, 2002).

The last two columns of Table B-1 indicate when limits were placed on the METS values generated by the specified distribution. For a given activity ID code, the CHAD randomly generates a METS value from the specified distribution. If "Truncate Left Tail?" equals "Y," then any METS value falling below the distribution's specified minimum was set to equal the minimum. Likewise, if "Truncate Right Tail?" equals "Y," then any METS value falling above the distribution's specified maximum was set to equal the maximum. Truncation of the left and right tails occurred with the normal and lognormal distributions, while truncation of the right tail only occurred with the exponential distribution. In such situations, more METS observations tend to occur at the minimum and/or maximum values. Note that truncation did not affect the initial random generation of METS values (i.e., randomization did not occur on truncated distributions).

Activity ID codes followed by "*" in Table B-1 were encountered within the NHAPS data set.

A total of ten activity ID codes that did not have a METS distribution assigned to them within CHAD were encountered in the NHAPS data set. These codes, listed in Table B-2, were occupation-related activity codes that appeared to represent subcodes to code 10000 (general work and other income-producing activities). Such subcodes may have required knowledge of the individual's occupation in order to assign the proper METS distribution to the activity. Because the occupation of the NHAPS participants was not specified in the activity data records within CHAD, the available information within CHAD was not sufficient to assign a METS distribution to these subcodes as CHAD would have done. Therefore, for each of these codes, it was necessary to identify an activity that was "similar" in description to the code and assign that activity's METS distribution to the code. Table B-2 specifies the activity whose METS distribution was assigned to each of these ten codes.

Table B-1. METS Distributions assigned to activity ID codes within CHAD

Activity Description	Activity ID Code	Age ^(a)	Occupation ^(b)	Distribution Type	Mean	Median	Std Dev	Min	Max	Truncate Left Tail?	Truncate Right Tail?
Work, general	10000		ADMIN	LogNormal	1.7	1.7	0.3	1.4	2.7	Y	Y
Work, general	10000		ADMSUP	LogNormal	1.7	1.7	0.3	1.4	2.7	Y	Y
Work, general	10000		FARM	LogNormal	7.5	7.0	3.0	3.6	17.0	Y	Y
Work, general	10000		HSHLD	LogNormal	3.6	3.5	0.8	2.5	6.0	Y	Y
Work, general	10000		MACH	Uniform	5.3	5.3	0.7	4.0	6.5		
Work, general	10000		PREC	Triangle	3.3	3.3	0.4	2.5	4.5	Y	Y
Work, general	10000		PROF	Triangle	2.9	2.7	1.0	1.2	5.6		
Work, general	10000		PROTECT	Triangle	2.9	2.7	1.0	1.2	5.6		
Work, general	10000		SALE	Triangle	2.9	2.7	1.0	1.2	5.6		
Work, general	10000		SERV	Triangle	5.2	5.3	1.4	1.6	8.4		
Work, general	10000		TECH	Triangle	3.3	3.3	0.4	2.5	4.5		
Work, general	10000		TRANS	LogNormal	3.3	3.0	1.5	1.3	8.4	Y	Y
Breaks	10300*			Uniform	1.8	1.8	0.4	1.0	2.5		
General household activities	11000			Triangle	4.7	4.6	1.3	1.5	8.0		
Prepare food	11100*			LogNormal	2.6	2.5	0.5	2.0	4.0	Y	Y
Prepare and clean-up food	11110			Exponential	2.8	2.5	0.9	1.9	4.0		Y
Indoor chores	11200			Exponential	3.4	3.0	1.4	2.0	5.0		Y
Clean-up food	11210*			Uniform	2.5	2.5	0.1	2.3	2.7		
Clean house	11220*			Exponential	4.1	3.5	1.9	2.2	5.0		Y

Outdoor chores	11300*		Normal	5.0	5.0	1.0	2.0	7.0	Y	Y
Clean outdoors	11310		Exponential	5.3	4.5	2.7	2.6	6.0		Y
Care of clothes	11400*		Exponential	2.2	2.0	0.7	1.5	4.0		Y
Wash clothes	11410		Point Est.	2.0	2.0		2.0	2.0		
Build a fire	11500		Point Est.	2.0	2.0		2.0	2.0		
Repair, general	11600		Normal	4.5	4.5	1.5	2.0	8.0	Y	Y
Repair of boat	11610		Point Est.	4.5	4.5		4.5	4.5		
Paint home / room	11620		Exponential	4.9	4.5	1.4	3.5	6.0		Y
Repair / maintain car	11630*		Triangle	3.5	3.4	0.4	3.0	4.5		
Home repairs	11640		Exponential	4.7	4.5	0.7	4.0	6.0		Y
Other repairs	11650*		Uniform	4.5	4.5	1.4	2.0	7.0		
Care of plants	11700*		Uniform	3.5	3.5	0.9	2.0	5.0		
Care for pets/animals	11800*		Uniform	3.3	3.3	0.1	3.0	3.5		
Other household	11900*		Exponential	6.6	5.5	3.6	3.0	9.0		Y

**Table B-1. METS Distributions assigned to activity ID codes within CHAD
(continued)**

Activity Description	Activity ID Code	Age ^(a)	Occupation ^(b)	Distribution Type	Mean	Median	Std Dev	Min	Max	Truncate Left Tail?	Truncate Right Tail?
Child care, general	12000			LogNormal	3.1	3.0	0.7	2.5	5.0	Y	Y
Care of baby	12100*			Uniform	3.3	3.3	0.1	3.0	3.5		
Care of child	12200*			Uniform	3.3	3.3	0.1	3.0	3.5		
Help / teach	12300*			Uniform	2.8	2.8	0.1	2.5	3.0		
Talk /read	12400*			Uniform	2.8	2.8	0.1	2.5	3.0		
Play indoors	12500*			Uniform	2.8	2.8	0.1	2.5	3.0		
Play outdoors	12600*			Uniform	4.5	4.5	0.3	4.0	5.0		
Medical care-child	12700*			Uniform	3.2	3.2	0.1	3.0	3.3		
Other child care	12800*			Uniform	3.0	3.0	0.3	2.5	3.5		
Obtain goods and services, general	13000			Triangle	3.8	3.7	0.8	2.0	6.0		
Dry clean	13100*			Uniform	3.3	3.3	0.4	2.5	4.0		
Shop / run errands	13200			Triangle	3.7	3.6	0.8	2.0	6.0		
Shop for food	13210*			Triangle	3.9	3.8	0.8	2.2	6.0		
Shop for clothes or household goods	13220*			Uniform	3.4	3.4	0.6	2.3	4.5		
Run errands	13230*			Uniform	3.5	3.5	0.6	2.5	4.5		
Obtain personal care service	13300*			Uniform	3.5	3.5	0.6	2.5	4.5		
Obtain medical service	13400*			Uniform	3.5	3.5	0.6	2.5	4.5		
Obtain government / financial services	13500*			Uniform	3.5	3.5	0.6	2.5	4.5		
Obtain car services	13600*			Uniform	3.5	3.5	0.6	2.5	4.5		
Other repairs	13700*			Uniform	3.5	3.5	0.6	2.5	4.5		

**Table B-1. METS Distributions assigned to activity ID codes within CHAD
(continued)**

Activity Description	Activity ID Code	Age^(a)	Occupation^(b)	Distribution Type	Mean	Median	Std Dev	Min	Max	Truncate Left Tail?	Truncate Right Tail?
Other services	13800*			Uniform	3.5	3.5	0.6	2.5	4.5		
Personal needs and care, general	14000			Uniform	2.0	2.0	0.6	1.0	3.0		
Shower, bathe, pers. hygiene	14100			Normal	2.0	2.0	0.3	1.0	4.0	Y	Y
Shower, bathe	14110*			Uniform	3.0	3.0	0.6	2.0	4.0		
Personal hygiene	14120*			Uniform	1.8	1.8	0.4	1.0	2.5		
Medical care	14200*			Uniform	1.8	1.8	0.4	1.0	2.5		
Help and care	14300*			LogNormal	3.1	3.0	0.7	2.5	5.0	Y	Y
Eat	14400*			Uniform	1.8	1.8	0.1	1.5	2.0		
Sleep or nap	14500*			LogNormal	0.9	0.9	0.1	0.8	1.1	Y	Y
Dress, groom	14600*			Point Est.	2.5	2.5		2.5	2.5		
Other personal needs	14700*			Triangle	2.0	2.0	0.4	1.0	2.9		
General educ. and pro. training	15000			LogNormal	1.9	1.8	0.7	1.4	4.0	Y	Y
Attend full-time school	15100*			Uniform	2.1	2.1	0.4	1.4	2.8		
Attend day-care	15110			Uniform	2.3	2.3	0.4	1.5	3.0		
Attend K-12	15120			Uniform	2.1	2.1	0.4	1.4	2.8		
Attend college or trade school	15130			Uniform	2.0	2.0	0.3	1.4	2.5		
Adult education and special training	15140			Uniform	1.8	1.8	0.2	1.4	2.2		
Attend other classes	15200*			Uniform	2.2	2.2	0.5	1.4	3.0		

**Table B-1. METS Distributions assigned to activity ID codes within CHAD
(continued)**

Activity Description	Activity ID Code	Age^(a)	Occupation^(b)	Distribution Type	Mean	Median	Std Dev	Min	Max	Truncate Left Tail?	Truncate Right Tail?
Do homework	15300*			Point Est.	1.8	1.8		1.8	1.8		
Use library	15400*			Uniform	2.3	2.3	0.4	1.5	3.0		
Other education	15500*			Uniform	2.8	2.8	0.7	1.5	4.0		
General entertainment / social activities	16000			LogNormal	2.2	2.0	1.1	1.0	6.0	Y	Y
Attend sports events	16100*			Uniform	2.7	2.7	0.8	1.4	4.0		
Participate in social, political, or religious activities	16200			Uniform	1.7	1.7	0.2	1.4	2.0		
Practice religion	16210*			Uniform	1.7	1.7	0.2	1.4	2.0		
Watch movie	16300*			Uniform	1.3	1.3	0.2	1.0	1.6		
Attend theater	16400*			Uniform	1.7	1.7	0.4	1.0	2.3		
Visit museums	16500*			Uniform	2.5	2.5	0.3	2.0	2.9		
Visit	16600*			Uniform	1.5	1.5	0.3	1.0	1.9		
Attend a party	16700*			LogNormal	3.3	3.0	1.4	1.5	8.0	Y	Y
Go to bar / lounge	16800*			LogNormal	3.3	3.0	1.4	1.5	8.0	Y	Y
Other entertainment / social events	16900*			Uniform	3.8	3.8	1.3	1.5	6.0		
Leisure, general	17000	20		LogNormal	5.7	5.0	3.0	1.4	16.0	Y	Y
Leisure, general	17000	30		Normal	5.0	5.0	2.0	1.0	9.0	Y	Y
Leisure, general	17000	40		Normal	4.5	4.5	1.4	1.7	7.3	Y	Y
Sports and active leisure	17100	20		LogNormal	5.7	5.0	3.0	1.4	16.0	Y	Y

**Table B-1. METS Distributions assigned to activity ID codes within CHAD
(continued)**

Activity Description	Activity ID Code	Age^(a)	Occupation^(b)	Distribution Type	Mean	Median	Std Dev	Min	Max	Truncate Left Tail?	Truncate Right Tail?
Sports and active leisure	17100	30		Normal	5.0	5.0	2.0	1.0	9.0	Y	Y
Sports and active leisure	17100	40		Normal	4.5	4.5	1.4	1.7	7.3	Y	Y
Participate in sports	17110*	20		LogNormal	3.6	3.2	1.9	1.4	10.0	Y	Y
Participate in sports	17110*	30		LogNormal	3.6	3.2	1.9	1.4	10.0	Y	Y
Participate in sports	17110*	40		LogNormal	3.4	3.0	1.7	1.4	9.0	Y	Y
Hunting, fishing, hiking	17111	20		Normal	5.6	5.6	2.1	1.4	9.8	Y	Y
Hunting, fishing, hiking	17111	30		Normal	5.8	5.8	2.4	1.0	10.6	Y	Y
Hunting, fishing, hiking	17111	40		Normal	4.7	4.7	1.8	1.1	8.3	Y	Y
Golf	17112	20		Uniform	3.8	3.8	1.0	2.0	5.5		
Golf	17112	30		Uniform	3.8	3.8	1.0	2.0	5.5		
Golf	17112	40		Uniform	3.5	3.5	0.9	2.0	5.0		
Bowling / pool / ping pong / pinball	17113			Uniform	3.0	3.0	0.6	2.0	4.0		
Yoga	17114			Triangle	3.1	3.2	0.6	1.4	4.0		
Participate in outdoor leisure	17120	20		LogNormal	4.2	3.9	1.5	2.0	9.0	Y	Y
Participate in outdoor leisure	17120	30		LogNormal	4.2	3.9	1.5	2.0	9.0	Y	Y
Participate in outdoor leisure	17120	40		Point Est.	3.5	3.5		0.0	0.0		
Play, unspecified	17121	20		LogNormal	4.2	3.9	1.5	2.0	9.0	Y	Y
Play, unspecified	17121	30		LogNormal	4.2	3.9	1.5	2.0	9.0	Y	Y

**Table B-1. METS Distributions assigned to activity ID codes within CHAD
(continued)**

Activity Description	Activity ID Code	Age ^(a)	Occupation ^(b)	Distribution Type	Mean	Median	Std Dev	Min	Max	Truncate Left Tail?	Truncate Right Tail?
Play, unspecified	17121	40		Point Est.	3.5	3.5		0.0	0.0		
Passive, sitting	17122*			Uniform	1.5	1.5	0.2	1.2	1.8		
Exercise	17130*	20		LogNormal	5.8	5.5	1.8	1.8	11.3	Y	Y
Exercise	17130*	30		Normal	5.7	5.7	1.8	2.1	9.3	Y	Y
Exercise	17130*	40		Normal	4.7	4.7	1.2	2.3	7.1	Y	Y
Walk, bike, or jog (not in transit)	17131	20		LogNormal	5.8	5.5	1.8	1.8	11.3	Y	Y
Walk, bike, or jog (not in transit)	17131	30		Normal	5.7	5.7	1.8	2.1	9.3	Y	Y
Walk, bike, or jog (not in transit)	17131	40		Normal	4.7	4.7	1.2	2.3	7.1	Y	Y
Create art, music, work on hobbies	17140	20		Normal	5.3	5.3	1.8	1.7	8.9	Y	Y
Create art, music, work on hobbies	17140	30		Normal	5.2	5.2	1.7	1.7	8.9	Y	Y
Create art, music, work on hobbies	17140	40		Normal	3.8	3.8	1.0	1.8	5.8	Y	Y
Participate in hobbies	17141*			Triangle	2.8	2.7	0.8	1.5	5.0		
Create domestic crafts	17142*			Triangle	2.0	1.9	0.4	1.5	3.0		
Create art	17143*			Uniform	2.5	2.5	0.3	2.0	3.0		
Perform music / drama / dance	17144*	20		Normal	5.3	5.3	1.8	1.7	8.9	Y	Y
Perform music / drama / dance	17144*	30		Normal	5.2	5.2	1.7	1.7	8.9	Y	Y

**Table B-1. METS Distributions assigned to activity ID codes within CHAD
(continued)**

Activity Description	Activity ID Code	Age^(a)	Occupation^(b)	Distribution Type	Mean	Median	Std Dev	Min	Max	Truncate Left Tail?	Truncate Right Tail?
Perform music / drama / dance	17144*	40		Normal	3.8	3.8	1.0	1.8	5.8	Y	Y
Play games	17150*			Triangle	3.3	3.2	0.6	2.4	5.0		
Use of computers	17160*			Uniform	1.6	1.6	0.2	1.2	2.0		
Recess and physical education	17170			Uniform	5.0	5.0	1.7	2.0	8.0		
Other sports and active leisure	17180	20		LogNormal	6.6	5.9	3.2	2.0	17.4	Y	Y
Other sports and active leisure	17180	30		Normal	6.0	6.0	2.0	2.0	10.0	Y	Y
Other sports and active leisure	17180	40		Normal	4.8	4.8	1.4	2.0	7.6	Y	Y
Participate in passive leisure	17200			LogNormal	1.3	1.3	0.3	1.0	2.3	Y	Y
Watch	17210			Uniform	1.5	1.5	0.2	1.2	1.8		
Watch adult at work	17211			Uniform	0.0	0.0	0.0	1.2	0.0		
Watch someone provide childcare	17212			Uniform	0.0	0.0	0.0	1.2	0.0		
Watch personal care	17213			Uniform	0.0	0.0	0.0	1.2	0.0		
Watch education	17214			Uniform	0.0	0.0	0.0	1.2	0.0		
Watch organizational activities	17215			Uniform	0.0	0.0	0.0	1.2	0.0		
Watch recreation	17216			Uniform	2.7	2.7	0.8	1.4	4.0		

**Table B-1. METS Distributions assigned to activity ID codes within CHAD
(continued)**

Activity Description	Activity ID Code	Age^(a)	Occupation^(b)	Distribution Type	Mean	Median	Std Dev	Min	Max	Truncate Left Tail?	Truncate Right Tail?
Listen to radio / recorded music / watch T.V.	17220			LogNormal	1.2	1.2	0.4	0.9	2.3	Y	Y
Listen to radio	17221*			Uniform	1.2	1.2	0.1	1.0	1.3		
Listen to recorded music	17222*			Uniform	1.9	1.9	0.2	1.5	2.3		
Watch TV	17223*			Point Est.	1.0	1.0		1.0	1.0		
Read, general	17230			Uniform	1.3	1.3	0.2	1.0	1.6		
Read books	17231*			Uniform	1.3	1.3	0.2	1.0	1.6		
Read magazines / not ascertained	17232*			Uniform	1.3	1.3	0.2	1.0	1.6		
Read newspaper	17233*			Uniform	1.3	1.3	0.2	1.0	1.6		
Converse / write	17240			Uniform	1.4	1.4	0.2	1.0	1.8		
Converse	17241*			Uniform	1.4	1.4	0.2	1.0	1.8		
Write for leisure / pleasure / paperwork	17242*			Uniform	1.4	1.4	0.2	1.0	1.8		
Think and relax	17250*			Uniform	1.2	1.2	0.1	1.0	1.3		
Other passive leisure	17260			Uniform	1.9	1.9	0.2	1.5	2.3		
Other leisure	17300			Uniform	1.5	1.5	0.2	1.2	1.8		
Travel, general	18000			LogNormal	2.3	2.0	1.3	1.0	7.0	Y	Y
Travel during work	18100*			LogNormal	2.3	2.0	1.3	1.0	7.0	Y	Y
Travel to/from work	18200*			LogNormal	2.3	2.0	1.3	1.0	7.0	Y	Y
Travel for child care	18300*			LogNormal	2.3	2.0	1.3	1.0	7.0	Y	Y

**Table B-1. METS Distributions assigned to activity ID codes within CHAD
(continued)**

Activity Description	Activity ID Code	Age ^(a)	Occupation ^(b)	Distribution Type	Mean	Median	Std Dev	Min	Max	Truncate Left Tail?	Truncate Right Tail?
Travel for goods and services	18400*			LogNormal	2.3	2.0	1.3	1.0	7.0	Y	Y
Travel for personal care	18500*			LogNormal	2.3	2.0	1.3	1.0	7.0	Y	Y
Travel for education	18600*			LogNormal	2.3	2.0	1.3	1.0	7.0	Y	Y
Travel for organ. activity	18700*			LogNormal	2.3	2.0	1.3	1.0	7.0	Y	Y
Travel for event / social act	18800*			LogNormal	2.3	2.0	1.3	1.0	7.0	Y	Y
Travel for leisure	18900			LogNormal	2.3	2.0	1.3	1.0	7.0	Y	Y
Travel for active leisure	18910*			LogNormal	2.3	2.0	1.3	1.0	7.0	Y	Y
Travel for passive leisure	18920*			LogNormal	2.3	2.0	1.3	1.8	7.0	Y	Y

^aAge Group (“20” = <25 years; “30” = 25–39 years; “40” = >40 years)

^bOccupation (activity ID code = 1000 only): ADMIN = executive/administrative/managerial; PROF = professional; TECH = technicians; SALE = sales; ADMSUP = administrative support; HSHLD = private household; PROTECT = protective services; SERV = service; FARM = farming/forestry/fishing; PREC = precision production/craft/repair; MACH = machine operators/assemblers/inspectors; TRANS = transportation and material moving; LABOR = handling/equipment cleaners/helpers/laborers

*Activity ID codes encountered within the NHAPS data set.

Table B-2. Activity codes whose METS Distributions were assigned to those codes encountered in the NHAPS Database but having no METS Distribution assigned by CHAD

Codes Encountered in the NHAPS Data with No METS Distribution Assigned by CHAD		Activity Code Whose METS Distribution Was Assigned to the Code in the First Column	
Activity Code	Activity Description	Activity Code	Activity Description
10111	Work for professional/union organizations	10000 (PROF)	Work and other income producing activities, general—professional positions
10112	Work for special interest identity organizations	16200	Participate in social, political, or religious activities
10113	Work for political party and civic participation	16200	Participate in social, political, or religious activities
10114	Work for volunteer/helping organizations	14300	Help and care
10115	Work of/for religious groups	16200	Participate in social, political, or religious activities
10116	Work for fraternal organizations	16200	Participate in social, political, or religious activities
10117	Work for child/youth/family organizations	12800	Other child care
10118	Work for other organizations	10000 (ADMIN)	Work and other income producing activities, general—executive, administrative, and managerial positions
10120	Work, income-related only	16900	Other entertainment/social events
10200	Unemployment	13500	Obtain government/financial services

APPENDIX C

ADDITIONAL ANALYSIS TABLES

LIST OF TABLES

C-1a. Descriptive statistics of body weight (kg) and BMR (kcal/min) across NHANES male participants, by age groupC-3

C-1b. Descriptive statistics of body weight (kg) and BMR (kcal/min) across NHANES female participants, by age groupC-4

C-2a. Descriptive statistics for daily average ventilation rate (m^3/day) in males, by age categoryC-5

C-2b. Descriptive statistics for daily average ventilation rate (m^3/day) in females, by age categoryC-6

C-3. Descriptive statistics for duration of time (hr/day) spent performing activities within the specified activity category, by age and gender categoriesC-7

C-4. Descriptive statistics for average ventilation rate (L/min), unadjusted for body weight, while performing activities within the specified activity category, by age and gender categoriesC-12

C-5. Descriptive statistics for average ventilation rate (L/min-kg), adjusted for body weight, while performing activities within the specified activity category, by age and gender categoriesC-17

C-6. Descriptive statistics for daily ventilation rate (m^3/min), unadjusted for body weight, while performing activities within the specified activity category, by age and gender categoriesC-22

C-7. Descriptive statistics for daily ventilation rate ($m^3/min-kg$), adjusted for body weight, while performing activities within the specified activity category, by age and gender categoriesC-27

Table C-1a. Descriptive statistics of body weight (kg) and BMR (kcal/min) across NHANES male participants, by age group

Age Category	Body Weight (kg)									BMR (kcal/min)								
	Mean	Percentiles							Maximum	Mean	Percentiles							Maximum
		5 th	10 th	25 th	50 th	75 th	90 th	95 th			5 th	10 th	25 th	50 th	75 th	90 th	95 th	
Birth to <1 year	8.0	4.8	5.5	6.7	8.1	9.4	10.4	10.8	13.4	0.31	0.18	0.21	0.26	0.31	0.37	0.41	0.42	0.53
1 year	11.4	9.1	9.8	10.3	11.3	12.3	13.2	13.7	16.1	0.45	0.35	0.38	0.40	0.45	0.49	0.52	0.54	0.64
2 years	13.9	11.1	11.7	12.5	13.8	15.3	16.2	17.2	23.3	0.55	0.44	0.46	0.50	0.55	0.61	0.65	0.69	0.94
3 to <6 years	18.5	13.4	14.5	16.0	17.8	20.2	23.3	25.2	42.0	0.64	0.56	0.58	0.60	0.63	0.67	0.72	0.75	1.01
6 to <11 years	31.8	19.9	21.9	24.8	29.6	36.3	45.4	50.0	86.9	0.85	0.66	0.70	0.74	0.82	0.91	1.04	1.11	1.57
11 to <16 years	56.4	32.8	35.2	43.3	53.8	65.7	79.9	92.5	143.6	1.15	0.86	0.89	0.99	1.12	1.26	1.44	1.59	2.22
16 to <21 years	76.5	54.3	57.6	63.9	72.2	83.6	102.8	111.2	176.0	1.33	1.08	1.11	1.18	1.28	1.42	1.60	1.73	2.62
21 to <31 years	83.8	56.8	60.9	69.5	80.8	93.7	108.7	123.4	196.8	1.35	1.07	1.12	1.21	1.32	1.45	1.62	1.74	2.54
31 to <41 years	87.1	61.0	65.6	73.9	83.4	96.3	112.6	126.7	193.3	1.30	1.09	1.13	1.19	1.27	1.37	1.50	1.61	2.14
41 to <51 years	88.4	64.0	67.7	76.7	85.4	97.8	111.8	121.2	188.3	1.31	1.12	1.14	1.22	1.29	1.38	1.50	1.57	2.11
51 to <61 years	89.0	62.6	67.4	76.6	86.6	99.6	110.5	120.3	179.0	1.30	1.07	1.12	1.20	1.29	1.39	1.48	1.55	2.03
61 to <71 years	87.6	63.4	66.7	76.1	85.7	97.1	111.2	119.0	162.8	1.12	0.92	0.95	1.03	1.10	1.20	1.31	1.38	1.73
71 to <81 years	82.4	60.6	64.4	72.5	81.0	92.0	101.1	108.8	132.7	1.08	0.90	0.93	1.00	1.07	1.16	1.23	1.29	1.49
81 years and older	75.4	57.9	61.8	67.0	74.6	82.0	91.6	100.5	111.8	1.02	0.88	0.91	0.95	1.01	1.07	1.15	1.22	1.32

Individual measures have been weighted by their 4-year sampling weights as assigned within NHANES 1999–2002 when calculating the statistics in this table. The numbers of male NHANES participants with data entering into these statistics are given in Table 2-1.

Table C-1b. Descriptive statistics of body weight (kg) and BMR (kcal/min) across NHANES female participants, by age group

Age Category	Body Weight (kg)									BMR (kcal/min)								
	Mean	Percentiles							Max	Mean	Percentiles							Max
		5 th	10 th	25 th	50 th	75 th	90 th	95 th			5 th	10 th	25 th	50 th	75 th	90 th	95 th	
Birth to <1 year	7.4	4.6	4.9	6.3	7.5	8.6	9.6	10.4	20.2	0.28	0.16	0.18	0.23	0.28	0.33	0.37	0.40	0.80
1 year	11.1	8.8	9.1	9.9	10.9	12.1	13.1	13.8	18.9	0.43	0.33	0.35	0.38	0.42	0.47	0.51	0.54	0.74
2 years	13.3	11.0	11.2	12.0	13.1	14.4	15.6	16.8	22.7	0.52	0.42	0.43	0.46	0.51	0.56	0.61	0.66	0.90
3 to <6 years	18.2	13.3	14.2	15.5	17.4	19.5	23.0	26.9	38.6	0.59	0.52	0.54	0.56	0.58	0.61	0.66	0.72	0.88
6 to <11 years	30.9	18.9	20.6	23.3	28.1	36.2	44.7	50.4	87.0	0.76	0.60	0.63	0.67	0.74	0.84	0.95	1.02	1.56
11 to <16 years	55.6	35.6	38.1	45.0	53.1	62.4	75.3	86.2	134.4	1.00	0.81	0.83	0.90	0.97	1.06	1.18	1.28	1.73
16 to <21 years	65.2	46.2	47.8	54.3	61.3	72.5	89.9	96.2	156.4	1.04	0.83	0.87	0.93	1.01	1.11	1.27	1.35	1.95
21 to <31 years	72.4	47.5	51.4	58.3	69.0	82.5	98.3	109.6	159.1	1.07	0.83	0.87	0.93	1.03	1.17	1.33	1.45	1.97
31 to <41 years	74.7	51.0	54.6	60.7	69.7	84.0	103.8	112.8	191.1	1.01	0.87	0.89	0.93	0.98	1.06	1.17	1.22	1.66
41 to <51 years	76.6	51.3	54.2	60.7	72.7	87.5	102.8	117.2	182.8	1.02	0.88	0.89	0.93	1.00	1.08	1.17	1.25	1.62
51 to <61 years	77.0	53.1	56.2	62.8	73.6	87.7	104.6	113.4	150.1	1.01	0.86	0.89	0.93	1.00	1.07	1.17	1.22	1.43
61 to <71 years	75.5	51.7	55.9	63.8	73.1	83.9	99.9	109.2	138.7	0.93	0.78	0.81	0.86	0.92	0.99	1.09	1.15	1.33
71 to <81 years	70.3	46.8	52.0	59.4	68.5	80.3	91.8	97.7	127.6	0.90	0.75	0.78	0.83	0.89	0.96	1.04	1.07	1.26
81 years and older	63.9	45.2	47.4	54.5	62.6	71.4	79.4	91.4	120.0	0.86	0.74	0.76	0.80	0.85	0.91	0.96	1.03	1.21

C-4

Individual measures have been weighted by their 4-year sampling weights as assigned within NHANES 1999–2002 when calculating the statistics in this table. The numbers of female NHANES participants with data entering into these statistics are given in Table 2-1.

Table C-2a. Descriptive statistics for daily average ventilation rate (m³/day) in males, by age category

Age Category	Daily Average Ventilation Rate, Unadjusted for Body Weight (\dot{V}_E ; m ³ /day)									Daily Average Ventilation Rate, Adjusted for Body Weight (\dot{V}_E/BW ; m ³ /day-kg)								
	Mean	Percentiles							Max	Mean	Percentiles							Max
		5 th	10 th	25 th	50 th	75 th	90 th	95 th			5 th	10 th	25 th	50 th	75 th	90 th	95 th	
Birth to <1 year	8.76	4.77	5.70	7.16	8.70	10.43	11.93	12.69	17.05	1.09	0.91	0.94	1.00	1.09	1.16	1.26	1.29	1.48
1 year	13.49	9.73	10.41	11.65	13.11	15.02	17.03	17.89	24.24	1.19	0.96	1.02	1.09	1.17	1.26	1.37	1.48	1.73
2 years	13.23	9.45	10.20	11.43	13.19	14.49	16.27	17.71	28.17	0.95	0.78	0.82	0.87	0.94	1.01	1.09	1.13	1.36
3 to <6 years	12.65	10.42	10.87	11.40	12.58	13.64	14.63	15.41	19.52	0.70	0.52	0.56	0.61	0.69	0.78	0.87	0.92	1.08
6 to <11 years	13.42	10.08	10.69	11.73	13.09	14.73	16.56	17.72	24.97	0.44	0.32	0.34	0.38	0.43	0.50	0.55	0.58	0.81
11 to <16 years	15.32	11.41	12.11	13.27	14.79	16.81	19.54	21.21	28.54	0.28	0.21	0.22	0.25	0.28	0.32	0.36	0.38	0.50
16 to <21 years	17.22	12.60	13.41	14.48	16.63	19.16	21.94	23.38	39.21	0.23	0.17	0.18	0.20	0.23	0.25	0.28	0.30	0.39
21 to <31 years	18.82	12.69	13.57	15.49	18.18	21.23	24.57	27.14	43.42	0.23	0.16	0.17	0.19	0.22	0.26	0.30	0.32	0.51
31 to <41 years	20.29	14.00	14.97	16.96	19.83	23.02	26.77	28.90	40.72	0.24	0.16	0.18	0.20	0.23	0.27	0.31	0.34	0.46
41 to <51 years	20.93	14.66	15.54	17.50	20.60	23.89	26.71	28.37	45.98	0.24	0.17	0.18	0.20	0.23	0.28	0.32	0.34	0.47
51 to <61 years	20.91	14.98	16.07	17.60	20.41	23.16	27.01	29.09	38.17	0.24	0.16	0.18	0.20	0.24	0.27	0.30	0.34	0.43
61 to <71 years	17.94	13.92	14.50	15.88	17.60	19.54	21.78	23.50	28.09	0.21	0.17	0.18	0.19	0.20	0.22	0.24	0.25	0.32
71 to <81 years	16.35	13.10	13.61	14.67	16.23	17.57	19.43	20.42	24.53	0.20	0.17	0.18	0.19	0.20	0.21	0.23	0.24	0.31
81 years and older	15.15	11.95	12.57	13.82	14.90	16.31	18.02	18.68	22.63	0.20	0.17	0.18	0.19	0.20	0.22	0.23	0.25	0.28

Individual daily averages are weighted by their 4-year sampling weights as assigned within NHANES 1999–2002 when calculating the statistics in this table. Ventilation rate was estimated using the multiple linear regression model in Section 3.6.

Table C-2b. Descriptive statistics for daily average ventilation rate (m³/day) in females, by age category

Age Category	Daily Average Ventilation Rate, Unadjusted for Body Weight (\dot{V}_E ; m ³ /day)									Daily Average Ventilation Rate, Adjusted for Body Weight (\dot{V}_E/BW ; m ³ /day-kg)								
	Mean	Percentiles							Max	Mean	Percentiles							Max
		5 th	10 th	25 th	50 th	75 th	90 th	95 th			5 th	10 th	25 th	50 th	75 th	90 th	95 th	
Birth to <1 year	8.53	4.84	5.48	6.83	8.41	9.78	11.65	12.66	26.26	1.14	0.91	0.97	1.04	1.13	1.24	1.33	1.38	1.60
1 year	13.31	9.08	10.12	11.24	13.03	14.64	17.45	18.62	24.77	1.20	0.97	1.01	1.10	1.18	1.30	1.41	1.46	1.73
2 years	12.74	8.91	10.07	11.38	12.60	13.96	15.58	16.37	23.01	0.95	0.82	0.84	0.89	0.96	1.01	1.07	1.11	1.23
3 to <6 years	12.16	9.87	10.38	11.20	12.02	13.01	14.03	14.93	19.74	0.69	0.48	0.54	0.60	0.68	0.77	0.88	0.92	1.12
6 to <11 years	12.41	9.99	10.35	11.01	11.95	13.42	15.13	16.34	20.82	0.43	0.28	0.31	0.36	0.43	0.49	0.55	0.58	0.75
11 to <16 years	13.44	10.47	11.11	12.04	13.08	14.54	16.25	17.41	26.58	0.25	0.19	0.20	0.22	0.24	0.28	0.31	0.34	0.47
16 to <21 years	13.59	9.86	10.61	11.78	13.20	15.02	17.12	18.29	30.11	0.21	0.16	0.17	0.19	0.21	0.24	0.27	0.28	0.36
21 to <31 years	14.57	10.15	10.67	11.93	14.10	16.62	19.32	21.14	30.23	0.21	0.14	0.16	0.18	0.20	0.23	0.26	0.28	0.40
31 to <41 years	14.98	11.07	11.80	13.02	14.68	16.32	18.51	20.45	28.28	0.21	0.14	0.15	0.18	0.20	0.23	0.27	0.30	0.43
41 to <51 years	16.20	12.10	12.58	14.16	15.88	17.95	19.91	21.35	35.89	0.22	0.15	0.16	0.19	0.21	0.25	0.28	0.31	0.41
51 to <61 years	16.18	12.33	12.96	14.08	15.90	17.81	19.93	21.22	25.70	0.22	0.15	0.16	0.18	0.21	0.24	0.28	0.30	0.40
61 to <71 years	12.99	10.40	10.77	11.78	12.92	13.90	15.40	16.15	20.34	0.18	0.14	0.15	0.16	0.17	0.19	0.21	0.22	0.27
71 to <81 years	12.04	9.90	10.20	10.89	11.82	12.96	14.11	15.20	17.70	0.18	0.14	0.14	0.16	0.17	0.19	0.21	0.23	0.34
81 years and older	11.14	9.19	9.45	10.13	11.02	11.87	12.85	13.94	16.93	0.18	0.14	0.15	0.16	0.18	0.20	0.21	0.22	0.28

C-6

Individual daily averages are weighted by their 4-year sampling weights as assigned within NHANES 1999–2002 when calculating the statistics in this table. Ventilation rate was estimated using the multiple linear regression model in Section 3.6.

Table C-3. Descriptive statistics for duration of time (hr/day) spent performing activities within the specified activity category, by age and gender categories

Age Category	Duration (hr/day) Spent at Activity - Males									Duration (hr/day) Spent at Activity - Females								
	Mean	Percentiles							Max	Mean	Percentiles							Max
		5 th	10 th	25 th	50 th	75 th	90 th	95 th			5 th	10 th	25 th	50 th	75 th	90 th	95 th	
Sleep or nap (Activity ID = 14500)																		
Birth to <1 year	13.51	12.63	12.78	13.19	13.53	13.88	14.24	14.46	15.03	12.99	12.00	12.16	12.53	12.96	13.44	13.82	14.07	14.82
1 year	12.61	11.89	12.15	12.34	12.61	12.89	13.13	13.29	13.79	12.58	11.59	11.88	12.29	12.63	12.96	13.16	13.31	14.55
2 years	12.06	11.19	11.45	11.80	12.07	12.39	12.65	12.75	13.40	12.09	11.45	11.68	11.86	12.08	12.34	12.57	12.66	13.48
3 to <6 years	11.18	10.57	10.70	10.94	11.18	11.45	11.63	11.82	12.39	11.13	10.45	10.70	10.92	11.12	11.38	11.58	11.75	12.23
6 to <11 years	10.18	9.65	9.75	9.93	10.19	10.39	10.59	10.72	11.24	10.26	9.55	9.73	10.01	10.27	10.54	10.74	10.91	11.43
11 to <16 years	9.38	8.84	8.94	9.15	9.38	9.61	9.83	9.95	10.33	9.57	8.82	8.97	9.27	9.55	9.87	10.17	10.31	11.52
16 to <21 years	8.69	7.91	8.08	8.36	8.67	9.03	9.34	9.50	10.44	9.08	8.26	8.44	8.74	9.08	9.39	9.79	10.02	11.11
21 to <31 years	8.36	7.54	7.70	8.02	8.36	8.67	9.03	9.23	9.77	8.60	7.89	7.99	8.26	8.59	8.90	9.20	9.38	10.35
31 to <41 years	8.06	7.36	7.50	7.77	8.06	8.36	8.59	8.76	9.82	8.31	7.54	7.70	7.98	8.28	8.59	8.92	9.17	10.22
41 to <51 years	7.89	7.15	7.30	7.58	7.88	8.17	8.48	8.68	9.38	8.32	7.58	7.75	7.99	8.31	8.63	8.93	9.13	10.02
51 to <61 years	7.96	7.29	7.51	7.69	7.96	8.23	8.48	8.66	9.04	8.12	7.36	7.53	7.81	8.11	8.43	8.73	8.85	9.29
61 to <71 years	8.31	7.65	7.78	8.01	8.30	8.60	8.83	9.01	9.66	8.40	7.67	7.88	8.15	8.40	8.68	8.93	9.09	9.80
71 to <81 years	8.51	7.80	8.02	8.27	8.53	8.74	8.99	9.10	9.89	8.58	7.85	8.01	8.26	8.55	8.89	9.19	9.46	10.34
81 years and older	9.24	8.48	8.64	8.97	9.25	9.54	9.74	9.96	10.69	9.11	8.35	8.53	8.84	9.10	9.34	9.73	10.04	10.55

Table C-3. Descriptive statistics for duration of time (hr/day) spent performing activities within the specified activity category, by age and gender categories (continued)

Age Category	Duration (hr/day) Spent at Activity - Males									Duration (hr/day) Spent at Activity - Females								
	Mean	Percentiles							Max	Mean	Percentiles							Max
		5 th	10 th	25 th	50 th	75 th	90 th	95 th			5 th	10 th	25 th	50 th	75 th	90 th	95 th	
Sedentary & Passive Activities (METs ≤ 1.5—Includes Sleep or Nap)																		
Birth to <1 year	14.95	13.82	14.03	14.49	14.88	15.44	15.90	16.12	17.48	14.07	12.86	13.05	13.53	14.08	14.54	15.08	15.49	16.14
1 year	14.27	13.22	13.33	13.76	14.25	14.74	15.08	15.38	16.45	14.32	13.02	13.25	13.73	14.31	14.88	15.36	15.80	16.40
2 years	14.62	13.52	13.67	14.11	14.54	15.11	15.60	15.77	17.28	14.86	13.81	13.95	14.44	14.81	15.32	15.78	16.03	16.91
3 to <6 years	14.12	13.01	13.18	13.54	14.03	14.53	15.26	15.62	17.29	14.27	12.88	13.15	13.56	14.23	14.82	15.43	15.85	17.96
6 to <11 years	13.51	12.19	12.45	12.86	13.30	13.85	14.82	15.94	19.21	13.97	12.49	12.74	13.22	13.82	14.50	15.34	16.36	18.68
11 to <16 years	13.85	12.39	12.65	13.06	13.61	14.30	15.41	16.76	18.79	14.19	12.38	12.76	13.34	14.05	14.82	15.87	16.81	19.27
16 to <21 years	13.21	11.39	11.72	12.32	13.08	13.97	14.83	15.44	18.70	13.58	11.80	12.17	12.79	13.52	14.29	15.08	15.67	16.96
21 to <31 years	12.41	10.69	11.06	11.74	12.39	13.09	13.75	14.16	15.35	12.59	10.97	11.29	11.88	12.60	13.21	13.75	14.19	16.24
31 to <41 years	12.31	10.73	10.98	11.61	12.24	12.98	13.63	14.05	15.58	12.29	10.91	11.14	11.61	12.24	12.91	13.50	13.90	15.18
41 to <51 years	12.32	10.56	11.00	11.67	12.30	12.95	13.67	13.98	15.48	12.22	10.78	11.08	11.56	12.18	12.82	13.40	13.79	15.17
51 to <61 years	13.06	11.47	11.86	12.36	13.03	13.72	14.38	14.76	15.95	12.66	11.08	11.40	12.08	12.64	13.30	13.89	14.12	15.80
61 to <71 years	14.49	12.96	13.24	13.76	14.48	15.16	15.72	16.24	17.50	14.25	12.89	13.16	13.68	14.22	14.86	15.38	15.69	17.14
71 to <81 years	15.90	14.22	14.67	15.25	15.94	16.65	17.11	17.46	18.47	15.38	13.66	14.20	14.76	15.41	16.05	16.62	16.94	17.90
81 years and older	16.58	15.13	15.45	15.92	16.64	17.21	17.70	18.06	18.76	16.48	14.87	15.09	15.80	16.59	17.15	17.71	18.07	19.13

Table C-3. Descriptive statistics for duration of time (hr/day) spent performing activities within the specified activity category, by age and gender categories (continued)

Age Category	Duration (hr/day) Spent at Activity - Males									Duration (hr/day) Spent at Activity - Females								
	Mean	Percentiles							Max	Mean	Percentiles							Max
		5 th	10 th	25 th	50 th	75 th	90 th	95 th			5 th	10 th	25 th	50 th	75 th	90 th	95 th	
Light Intensity Activities (1.5 < METS ≤ 3.0)																		
Birth to <1 year	5.30	2.97	3.25	3.71	4.52	7.29	8.08	8.50	9.91	6.00	3.49	3.70	4.26	5.01	8.43	9.31	9.77	10.53
1 year	5.52	2.68	2.89	3.37	4.31	8.23	9.04	9.73	10.90	5.61	2.83	2.94	3.46	4.39	8.28	9.03	9.39	10.57
2 years	5.48	3.06	3.26	3.85	4.58	7.58	8.83	9.04	9.92	5.78	3.20	3.54	4.29	5.33	7.48	8.46	8.74	9.93
3 to <6 years	6.60	3.86	4.25	5.16	6.20	8.26	9.31	9.70	10.74	6.25	3.78	4.10	4.79	5.84	7.86	8.84	9.38	10.32
6 to <11 years	7.62	5.07	5.57	6.63	7.63	8.72	9.78	10.12	11.59	7.27	4.63	5.46	6.33	7.17	8.34	9.42	9.79	11.06
11 to <16 years	7.50	4.48	5.59	6.75	7.67	8.51	9.19	9.63	10.91	7.55	4.89	5.62	6.75	7.67	8.55	9.27	9.57	10.85
16 to <21 years	7.13	4.37	4.97	6.00	7.02	8.29	9.43	10.03	11.50	6.98	4.60	5.08	5.91	6.85	7.96	9.16	9.57	12.29
21 to <31 years	6.09	3.15	3.50	4.20	5.08	8.49	9.96	10.47	12.25	6.42	3.66	4.09	4.84	5.82	8.18	9.56	10.14	12.11
31 to <41 years	5.72	2.80	3.12	3.70	4.64	8.34	9.87	10.49	12.10	6.51	4.06	4.33	5.06	5.98	8.14	9.46	9.93	13.12
41 to <51 years	6.07	2.97	3.41	3.92	4.82	8.56	10.19	10.79	12.68	6.56	3.99	4.30	4.97	5.90	8.40	9.75	10.18	11.83
51 to <61 years	5.64	3.21	3.44	4.03	4.79	7.59	8.94	9.75	12.09	6.52	4.09	4.42	5.19	6.05	7.95	9.12	9.43	11.58
61 to <71 years	5.49	3.50	3.82	4.58	5.29	6.41	7.40	7.95	10.23	6.23	4.40	4.74	5.47	6.23	6.96	7.67	8.17	11.13
71 to <81 years	4.96	3.45	3.75	4.29	4.81	5.59	6.26	6.59	9.90	5.96	4.22	4.51	5.24	5.92	6.63	7.46	7.91	9.43
81 years and older	4.86	3.54	3.71	4.17	4.74	5.39	6.33	6.59	7.56	5.30	3.67	3.96	4.63	5.16	6.00	6.70	7.01	8.78

Table C-3. Descriptive statistics for duration of time (hr/day) spent performing activities within the specified activity category, by age and gender categories (continued)

Age Category	Duration (hr/day) Spent at Activity - Males									Duration (hr/day) Spent at Activity - Females									
	Mean	Percentiles							Max	Mean	Percentiles							Max	
		5 th	10 th	25 th	50 th	75 th	90 th	95 th			5 th	10 th	25 th	50 th	75 th	90 th	95 th		
Moderate Intensity Activities (3.0 < METS ≤ 6.0)																			
Birth to <1 year	3.67	0.63	0.97	1.74	4.20	5.20	5.80	6.21	7.52	3.91	0.53	0.74	1.10	4.87	5.77	6.27	6.54	7.68	
1 year	4.04	0.45	0.59	1.14	5.29	6.06	6.61	6.94	7.68	4.02	0.52	0.73	1.08	5.14	6.10	7.00	7.37	8.07	
2 years	3.83	0.59	0.76	1.23	4.74	5.37	5.82	6.15	7.40	3.27	0.50	0.78	1.22	4.01	4.88	5.35	5.57	6.93	
3 to <6 years	3.15	0.55	0.75	1.30	3.80	4.52	5.11	5.32	6.30	3.35	0.70	0.89	1.61	3.88	4.71	5.29	5.65	7.58	
6 to <11 years	2.66	0.65	0.92	1.65	2.68	3.57	4.36	4.79	5.95	2.57	0.65	0.95	1.82	2.66	3.41	3.95	4.32	6.10	
11 to <16 years	2.35	0.88	1.09	1.66	2.30	3.02	3.62	3.89	5.90	2.01	0.89	1.08	1.45	1.96	2.51	3.03	3.28	4.96	
16 to <21 years	3.35	1.13	1.42	2.19	3.45	4.37	5.24	5.59	6.83	3.26	1.27	1.48	2.21	3.39	4.24	4.74	5.07	6.68	
21 to <31 years	5.24	1.15	1.58	2.52	6.01	7.15	7.95	8.39	9.94	4.80	1.62	1.94	2.78	5.37	6.42	7.19	7.52	9.21	
31 to <41 years	5.69	1.26	1.65	2.84	6.67	7.75	8.45	8.90	9.87	5.00	1.71	2.06	3.09	5.41	6.60	7.31	7.58	9.59	
41 to <51 years	5.40	1.21	1.55	2.39	6.46	7.57	8.40	8.85	10.52	5.05	1.75	2.00	2.97	5.48	6.66	7.50	7.97	10.16	
51 to <61 years	5.00	1.29	1.63	2.72	5.68	6.75	7.60	8.01	9.94	4.58	1.71	2.13	3.10	4.79	5.98	6.89	7.14	8.97	
61 to <71 years	3.73	1.62	1.97	2.81	3.70	4.67	5.45	6.01	7.45	3.31	1.65	1.97	2.56	3.34	4.01	4.61	5.01	6.90	
71 to <81 years	2.87	1.56	1.83	2.28	2.86	3.45	3.95	4.31	5.44	2.48	1.19	1.36	1.82	2.48	2.99	3.64	4.01	5.63	
81 years and older	2.35	1.32	1.45	1.79	2.29	2.85	3.28	3.61	4.37	2.06	1.01	1.25	1.55	1.99	2.51	3.07	3.44	4.68	

Table C-3. Descriptive statistics for duration of time (hr/day) spent performing activities within the specified activity category, by age and gender categories (continued)

Age Category	Duration (hr/day) Spent at Activity - Males									Duration (hr/day) Spent at Activity - Females								
	Mean	Percentiles							Max	Mean	Percentiles							Max
		5 th	10 th	25 th	50 th	75 th	90 th	95 th			5 th	10 th	25 th	50 th	75 th	90 th	95 th	
High Intensity (METs > 6.0)																		
Birth to <1 year	0.20	0.00	0.00	0.01	0.14	0.28	0.50	0.59	0.96	0.17	0.03	0.05	0.09	0.14	0.21	0.33	0.40	0.58
1 year	0.31	0.01	0.01	0.03	0.22	0.56	0.78	0.93	1.52	0.22	0.03	0.05	0.09	0.18	0.35	0.40	0.43	0.48
2 years	0.10	0.00	0.01	0.03	0.05	0.14	0.25	0.33	0.48	0.15	0.00	0.01	0.03	0.08	0.16	0.48	0.65	1.01
3 to <6 years	0.27	0.02	0.03	0.04	0.13	0.33	0.75	1.16	1.48	0.19	0.01	0.02	0.05	0.10	0.22	0.46	0.73	1.43
6 to <11 years	0.32	0.01	0.01	0.03	0.13	0.38	1.10	1.50	3.20	0.24	0.02	0.03	0.06	0.12	0.26	0.67	0.98	1.71
11 to <16 years	0.38	0.03	0.04	0.10	0.21	0.47	1.03	1.34	2.35	0.30	0.03	0.04	0.08	0.19	0.40	0.66	0.96	3.16
16 to <21 years	0.40	0.03	0.04	0.14	0.27	0.53	0.99	1.29	2.59	0.24	0.01	0.03	0.08	0.18	0.34	0.51	0.60	1.61
21 to <31 years	0.33	0.02	0.05	0.11	0.27	0.45	0.69	0.85	1.95	0.26	0.03	0.05	0.10	0.19	0.36	0.56	0.67	1.40
31 to <41 years	0.38	0.03	0.07	0.14	0.28	0.51	0.83	1.03	1.77	0.25	0.03	0.05	0.09	0.19	0.33	0.52	0.72	1.40
41 to <51 years	0.34	0.03	0.05	0.09	0.23	0.50	0.78	1.00	2.40	0.26	0.03	0.04	0.09	0.20	0.36	0.55	0.68	1.49
51 to <61 years	0.41	0.03	0.05	0.13	0.34	0.59	0.87	1.13	1.95	0.34	0.03	0.04	0.12	0.28	0.50	0.74	0.85	1.58
61 to <71 years	0.37	0.03	0.05	0.13	0.28	0.49	0.80	1.08	2.21	0.32	0.03	0.04	0.10	0.23	0.46	0.68	0.89	1.77
71 to <81 years	0.39	0.01	0.03	0.10	0.29	0.57	0.90	1.11	2.06	0.29	0.03	0.05	0.10	0.25	0.43	0.60	0.71	1.24
81 years and older	0.32	0.02	0.03	0.08	0.25	0.47	0.71	0.88	1.76	0.26	0.02	0.03	0.09	0.21	0.38	0.59	0.71	1.23

Individual measures are weighted by their 4-year sampling weights as assigned within NHANES 1999–2002 when calculating the statistics in this table. Ventilation rate was estimated using the multiple linear regression model in Section 3.6.

Table C-4. Descriptive statistics for average ventilation rate (L/min), unadjusted for body weight, while performing activities within the specified activity category, by age and gender categories

Age Category	Average Ventilation Rate (L/min) - Males, Unadjusted for Body Weight									Average Ventilation Rate (L/min) - Females, Unadjusted for Body Weight								
	Mean	Percentiles							Max	Mean	Percentiles							Max
		5 th	10 th	25 th	50 th	75 th	90 th	95 th			5 th	10 th	25 th	50 th	75 th	90 th	95 th	
Sleep or nap (Activity ID = 14500)																		
Birth to <1 year	3.08	1.66	1.91	2.45	3.00	3.68	4.35	4.77	7.19	2.92	1.54	1.72	2.27	2.88	3.50	4.04	4.40	8.69
1 year	4.50	3.11	3.27	3.78	4.35	4.95	5.90	6.44	10.02	4.59	3.02	3.28	3.76	4.56	5.32	5.96	6.37	9.59
2 years	4.61	3.01	3.36	3.94	4.49	5.21	6.05	6.73	8.96	4.56	3.00	3.30	3.97	4.52	5.21	5.76	6.15	9.48
3 to <6 years	4.36	3.06	3.30	3.76	4.29	4.86	5.54	5.92	7.67	4.18	2.90	3.20	3.62	4.10	4.71	5.22	5.73	7.38
6 to <11 years	4.61	3.14	3.39	3.83	4.46	5.21	6.01	6.54	9.94	4.36	2.97	3.17	3.69	4.24	4.93	5.67	6.08	8.42
11 to <16 years	5.26	3.53	3.78	4.34	5.06	5.91	6.94	7.81	11.49	4.81	3.34	3.57	3.99	4.66	5.39	6.39	6.99	9.39
16 to <21 years	5.31	3.55	3.85	4.35	5.15	6.09	6.92	7.60	12.82	4.40	2.78	2.96	3.58	4.26	5.05	5.89	6.63	12.25
21 to <31 years	4.73	3.16	3.35	3.84	4.56	5.42	6.26	6.91	11.17	3.89	2.54	2.74	3.13	3.68	4.44	5.36	6.01	9.58
31 to <41 years	5.16	3.37	3.62	4.23	5.01	5.84	6.81	7.46	10.86	4.00	2.66	2.86	3.31	3.89	4.54	5.28	5.77	8.10
41 to <51 years	5.65	3.74	4.09	4.73	5.53	6.47	7.41	7.84	10.84	4.40	3.00	3.23	3.69	4.25	4.95	5.66	6.25	8.97
51 to <61 years	5.78	3.96	4.20	4.78	5.57	6.54	7.74	8.26	11.81	4.56	3.12	3.30	3.72	4.41	5.19	6.07	6.63	8.96
61 to <71 years	5.98	4.36	4.57	5.13	5.81	6.68	7.45	7.93	12.27	4.47	3.22	3.35	3.78	4.38	4.99	5.72	6.37	9.57
71 to <81 years	6.07	4.26	4.55	5.17	6.00	6.77	7.65	8.33	10.50	4.52	3.31	3.47	3.89	4.40	5.11	5.67	6.06	7.35
81 years and older	5.97	4.20	4.49	5.23	5.90	6.68	7.36	7.76	9.98	4.49	3.17	3.49	3.82	4.39	4.91	5.61	6.16	8.27

Table C-4. Descriptive statistics for average ventilation rate (L/min), unadjusted for body weight, while performing activities within the specified activity category, by age and gender categories (continued)

Age Category	Average Ventilation Rate (L/min) - Males, Unadjusted for Body Weight									Average Ventilation Rate (L/min) - Females, Unadjusted for Body Weight								
	Mean	Percentiles							Max	Mean	Percentiles							Max
		5 th	10 th	25 th	50 th	75 th	90 th	95 th			5 th	10 th	25 th	50 th	75 th	90 th	95 th	
Sedentary & Passive Activities (METs ≤ 1.5—Includes Sleep or Nap)																		
Birth to <1 year	3.18	1.74	1.99	2.50	3.10	3.80	4.40	4.88	7.09	3.00	1.60	1.80	2.32	2.97	3.58	4.11	4.44	9.59
1 year	4.62	3.17	3.50	3.91	4.49	5.03	5.95	6.44	9.91	4.71	3.26	3.44	3.98	4.73	5.30	5.95	6.63	9.50
2 years	4.79	3.25	3.66	4.10	4.69	5.35	6.05	6.71	9.09	4.73	3.34	3.53	4.19	4.67	5.25	5.75	6.22	9.42
3 to <6 years	4.58	3.47	3.63	4.07	4.56	5.03	5.58	5.82	7.60	4.40	3.31	3.49	3.95	4.34	4.84	5.29	5.73	7.08
6 to <11 years	4.87	3.55	3.78	4.18	4.72	5.40	6.03	6.58	9.47	4.64	3.41	3.67	4.04	4.51	5.06	5.88	6.28	8.31
11 to <16 years	5.64	4.03	4.30	4.79	5.43	6.26	7.20	7.87	11.08	5.21	3.90	4.16	4.53	5.09	5.68	6.53	7.06	9.07
16 to <21 years	5.76	4.17	4.42	4.93	5.60	6.43	7.15	7.76	13.45	4.76	3.26	3.56	4.03	4.69	5.32	6.05	6.60	11.82
21 to <31 years	5.11	3.76	3.99	4.33	5.00	5.64	6.42	6.98	10.30	4.19	3.04	3.19	3.55	4.00	4.63	5.38	6.02	9.22
31 to <41 years	5.57	3.99	4.42	4.86	5.45	6.17	6.99	7.43	9.98	4.33	3.22	3.45	3.77	4.24	4.80	5.33	5.79	7.70
41 to <51 years	6.11	4.65	4.92	5.37	6.02	6.65	7.46	7.77	10.53	4.75	3.60	3.82	4.18	4.65	5.19	5.74	6.26	8.70
51 to <61 years	6.27	4.68	5.06	5.50	6.16	6.89	7.60	8.14	10.39	4.96	3.78	4.00	4.36	4.87	5.44	6.06	6.44	8.30
61 to <71 years	6.54	5.02	5.31	5.85	6.47	7.12	7.87	8.22	10.86	4.89	3.81	4.02	4.34	4.81	5.30	5.86	6.29	8.18
71 to <81 years	6.65	5.26	5.55	5.96	6.59	7.18	7.81	8.26	9.92	4.95	4.07	4.13	4.41	4.89	5.42	5.89	6.15	7.59
81 years and older	6.44	5.09	5.37	5.82	6.43	7.01	7.57	7.90	9.13	4.89	3.93	4.10	4.39	4.79	5.25	5.71	6.12	7.46

Table C-4. Descriptive statistics for average ventilation rate (L/min), unadjusted for body weight, while performing activities within the specified activity category, by age and gender categories (continued)

Age Category	Average Ventilation Rate (L/min) - Males, Unadjusted for Body Weight									Average Ventilation Rate (L/min) - Females, Unadjusted for Body Weight								
	Mean	Percentiles							Max	Mean	Percentiles							Max
		5 th	10 th	25 th	50 th	75 th	90 th	95 th			5 th	10 th	25 th	50 th	75 th	90 th	95 th	
Light Intensity Activities (1.5 < METS ≤ 3.0)																		
Birth to <1 year	7.94	4.15	5.06	6.16	7.95	9.57	10.76	11.90	15.50	7.32	3.79	4.63	5.73	7.19	8.73	9.82	10.80	16.97
1 year	11.56	8.66	8.99	9.89	11.42	12.91	14.39	15.76	21.12	11.62	8.59	8.80	10.03	11.20	12.94	15.17	15.80	20.22
2 years	11.67	8.52	9.14	9.96	11.37	13.02	14.66	15.31	18.98	11.99	8.74	9.40	10.27	11.69	13.17	15.63	16.34	23.61
3 to <6 years	11.36	9.20	9.55	10.23	11.12	12.28	13.40	14.00	19.65	10.92	8.83	9.04	9.87	10.69	11.74	12.85	13.81	16.43
6 to <11 years	11.64	8.95	9.33	10.20	11.26	12.79	14.60	15.60	21.83	11.07	8.51	9.02	9.79	10.79	11.98	13.47	14.67	22.22
11 to <16 years	13.22	9.78	10.26	11.34	12.84	14.65	16.42	18.65	26.86	12.02	9.40	9.73	10.63	11.76	13.09	14.66	15.82	22.10
16 to <21 years	13.41	10.01	10.54	11.53	12.95	14.95	16.95	18.00	29.07	11.08	8.31	8.73	9.64	10.76	12.27	13.80	14.92	21.40
21 to <31 years	12.97	9.68	10.18	11.25	12.42	14.04	16.46	17.74	27.22	10.55	7.75	8.24	9.05	10.24	11.67	13.40	14.26	21.46
31 to <41 years	13.64	10.63	11.05	11.99	13.33	14.83	16.46	18.10	25.50	11.07	8.84	9.30	9.96	10.94	11.93	13.11	13.87	17.40
41 to <51 years	14.38	11.16	11.81	12.95	14.11	15.61	17.39	18.25	23.01	11.78	9.64	10.00	10.67	11.61	12.66	13.85	14.54	17.67
51 to <61 years	14.56	11.08	11.58	12.97	14.35	15.90	17.96	19.37	25.48	12.02	9.76	10.17	10.87	11.79	12.97	14.23	14.87	17.94
61 to <71 years	14.12	11.07	11.74	12.69	13.87	15.37	16.91	17.97	20.54	10.82	8.87	9.28	9.85	10.64	11.67	12.62	13.21	17.40
71 to <81 years	13.87	11.17	11.68	12.73	13.69	14.96	16.23	16.89	20.02	10.83	8.84	9.23	9.94	10.74	11.69	12.52	13.01	17.59
81 years and older	13.76	11.02	11.71	12.56	13.75	14.70	16.03	16.72	20.71	10.40	8.69	8.84	9.36	10.29	11.37	12.06	12.63	16.05

Table C-4. Descriptive statistics for average ventilation rate (L/min), unadjusted for body weight, while performing activities within the specified activity category, by age and gender categories (continued)

Age Category	Average Ventilation Rate (L/min) - Males, Unadjusted for Body Weight									Average Ventilation Rate (L/min) - Females, Unadjusted for Body Weight									
	Mean	Percentiles							Max	Mean	Percentiles							Max	
		5 th	10 th	25 th	50 th	75 th	90 th	95 th			5 th	10 th	25 th	50 th	75 th	90 th	95 th		
Moderate Intensity Activities (3.0 < METS ≤ 6.0)																			
Birth to <1 year	14.49	7.41	8.81	11.46	14.35	16.95	20.08	22.50	30.54	13.98	7.91	9.00	11.15	13.53	16.32	19.41	22.30	40.87	
1 year	21.35	14.48	15.88	18.03	20.62	24.06	26.94	28.90	39.87	20.98	15.62	16.30	17.92	20.14	23.51	27.09	29.25	34.53	
2 years	21.54	15.37	16.71	18.42	20.82	24.07	26.87	29.68	50.93	21.34	14.21	15.57	18.17	21.45	23.92	27.61	28.76	37.58	
3 to <6 years	21.03	16.31	17.16	18.72	20.55	22.94	25.60	27.06	34.88	20.01	15.26	16.32	17.84	19.76	21.61	23.83	25.89	32.86	
6 to <11 years	22.28	16.36	17.23	19.34	21.64	25.00	27.59	29.50	43.39	21.00	15.98	16.83	18.47	20.39	22.98	26.06	28.08	43.13	
11 to <16 years	26.40	19.33	20.45	22.60	25.41	29.19	33.77	36.93	55.02	23.55	18.16	19.47	20.83	23.04	25.38	28.42	31.41	42.42	
16 to <21 years	29.02	20.30	21.69	24.52	27.97	31.74	38.15	42.14	67.35	23.22	16.60	17.61	19.62	22.39	26.13	30.28	31.98	52.47	
21 to <31 years	29.19	19.65	20.97	24.16	27.92	33.00	38.79	43.11	71.71	22.93	15.56	16.68	18.98	21.94	26.02	30.02	32.84	54.18	
31 to <41 years	30.30	21.40	22.70	25.08	29.09	34.10	39.60	43.48	57.69	22.70	16.87	17.57	19.50	21.95	24.81	28.94	31.10	47.27	
41 to <51 years	31.58	22.58	24.44	27.21	30.44	35.11	40.28	44.97	63.36	24.49	17.60	18.88	20.79	23.94	27.41	30.79	33.58	50.67	
51 to <61 years	32.71	22.36	24.01	27.95	31.40	36.96	41.66	45.77	70.48	25.24	18.83	19.80	21.78	24.30	28.11	31.87	35.02	46.18	
61 to <71 years	29.76	22.47	24.04	26.05	29.22	32.27	36.93	39.98	52.26	21.42	16.90	17.70	19.22	20.86	23.22	25.72	27.32	35.45	
71 to <81 years	29.29	22.81	23.92	26.14	28.78	32.04	35.65	37.32	44.86	21.09	16.86	17.61	18.87	20.68	22.85	24.94	26.35	34.41	
81 years and older	28.53	22.45	23.36	25.47	28.19	31.03	33.44	35.52	41.11	20.87	16.51	17.53	19.09	20.62	22.51	24.59	26.01	29.27	

Table C-4. Descriptive statistics for average ventilation rate (L/min), unadjusted for body weight, while performing activities within the specified activity category, by age and gender categories (continued)

Age Category	Average Ventilation Rate (L/min) - Males, Unadjusted for Body Weight									Average Ventilation Rate (L/min) - Females, Unadjusted for Body Weight								
	Mean	Percentiles							Max	Mean	Percentiles							Max
		5 th	10 th	25 th	50 th	75 th	90 th	95 th			5 th	10 th	25 th	50 th	75 th	90 th	95 th	
High Intensity (METs > 6.0)																		
Birth to <1 year	27.47	15.07	17.26	20.63	27.79	32.47	38.41	42.24	57.90	24.19	12.36	13.26	17.15	22.45	29.27	35.59	40.67	74.55
1 year	40.25	28.33	31.68	34.66	39.80	44.34	51.62	55.92	60.66	36.48	25.94	26.24	30.42	36.11	41.97	47.28	48.64	76.97
2 years	40.45	28.15	29.74	34.45	40.57	46.17	51.90	55.06	92.01	37.58	28.99	30.51	32.33	36.43	40.81	48.07	51.36	73.01
3 to <6 years	39.04	29.46	31.35	34.01	37.80	43.23	48.93	52.22	66.17	34.53	27.00	28.21	29.98	33.33	37.63	43.22	44.72	56.62
6 to <11 years	43.62	30.66	32.76	35.77	41.94	49.52	56.58	62.40	89.86	39.39	28.59	30.13	33.66	38.02	44.08	50.48	54.60	82.88
11 to <16 years	50.82	34.31	36.84	41.53	49.12	57.40	66.25	72.92	122.91	46.56	31.06	33.76	38.76	45.34	52.90	60.81	66.32	102.37
16 to <21 years	53.17	35.96	38.33	43.51	50.51	59.33	71.45	83.03	129.88	44.09	28.69	30.61	36.51	42.71	50.23	58.15	63.44	108.83
21 to <31 years	53.91	33.55	37.95	44.83	51.51	61.63	72.38	82.07	111.94	45.68	28.84	31.18	36.65	43.10	52.22	61.93	68.91	107.89
31 to <41 years	54.27	37.79	40.36	45.43	52.05	61.21	71.42	77.35	103.88	44.44	30.27	32.93	37.02	42.23	50.45	59.54	65.26	89.51
41 to <51 years	57.31	38.31	42.47	48.29	55.20	64.45	75.61	84.39	110.28	46.98	31.04	34.02	38.35	45.61	54.06	61.52	67.40	88.72
51 to <61 years	58.42	38.95	41.57	48.65	55.90	65.95	78.57	86.46	140.74	47.35	31.54	34.82	39.38	45.69	54.07	62.30	68.75	84.40
61 to <71 years	54.13	36.28	39.51	45.17	52.41	60.81	71.96	75.23	102.16	40.02	27.56	30.63	34.59	38.71	45.30	50.81	56.42	71.34
71 to <81 years	52.46	36.99	39.50	44.12	49.95	58.95	67.56	76.45	97.34	40.64	28.49	30.08	34.25	39.56	46.98	51.96	54.07	75.25
81 years and older	53.31	35.35	39.17	45.51	50.93	61.18	69.55	77.05	96.76	41.88	28.48	30.09	34.35	41.38	47.57	55.58	58.33	72.12

C-16

Individual measures are weighted by their 4-year sampling weights as assigned within NHANES 1999–2002 when calculating the statistics in this table. Ventilation rate was estimated using the multiple linear regression model in Section 3.6.

Table C-5. Descriptive statistics for average ventilation rate (L/min-kg), adjusted for body weight, while performing activities within the specified activity category, by age and gender categories

Age Category	Average Ventilation Rate (L/min-kg) - Males, Adjusted for Body Weight									Average Ventilation Rate (L/min-kg) - Females, Adjusted for Body Weight								
	Mean	Percentiles							Max	Mean	Percentiles							Max
		5 th	10 th	25 th	50 th	75 th	90 th	95 th			5 th	10 th	25 th	50 th	75 th	90 th	95 th	
Sleep or nap (Activity ID = 14500)																		
Birth to <1 year	0.38	0.28	0.30	0.34	0.38	0.43	0.46	0.50	0.67	0.39	0.28	0.30	0.34	0.39	0.43	0.48	0.52	0.74
1 year	0.40	0.30	0.31	0.35	0.38	0.44	0.49	0.52	0.63	0.41	0.31	0.33	0.36	0.41	0.46	0.52	0.54	0.66
2 years	0.33	0.25	0.26	0.29	0.33	0.36	0.40	0.44	0.54	0.34	0.26	0.27	0.29	0.33	0.39	0.43	0.45	0.49
3 to <6 years	0.24	0.16	0.17	0.20	0.24	0.28	0.31	0.35	0.48	0.24	0.14	0.16	0.20	0.23	0.28	0.32	0.35	0.52
6 to <11 years	0.15	0.10	0.11	0.13	0.15	0.17	0.20	0.22	0.30	0.15	0.09	0.10	0.12	0.15	0.18	0.21	0.23	0.30
11 to <16 years	0.10	0.07	0.07	0.08	0.09	0.11	0.13	0.14	0.21	0.09	0.06	0.07	0.07	0.09	0.10	0.12	0.13	0.18
16 to <21 years	0.07	0.05	0.05	0.06	0.07	0.08	0.09	0.10	0.15	0.07	0.04	0.05	0.06	0.07	0.08	0.09	0.10	0.15
21 to <31 years	0.06	0.04	0.04	0.05	0.06	0.07	0.08	0.08	0.13	0.06	0.04	0.04	0.04	0.05	0.06	0.07	0.08	0.10
31 to <41 years	0.06	0.04	0.04	0.05	0.06	0.07	0.08	0.09	0.13	0.06	0.03	0.04	0.04	0.05	0.06	0.08	0.08	0.11
41 to <51 years	0.07	0.04	0.05	0.05	0.06	0.07	0.09	0.09	0.14	0.06	0.04	0.04	0.05	0.06	0.07	0.08	0.09	0.11
51 to <61 years	0.07	0.05	0.05	0.05	0.06	0.08	0.09	0.09	0.14	0.06	0.04	0.04	0.05	0.06	0.07	0.08	0.09	0.13
61 to <71 years	0.07	0.05	0.05	0.06	0.07	0.08	0.09	0.09	0.12	0.06	0.04	0.05	0.05	0.06	0.07	0.08	0.08	0.10
71 to <81 years	0.07	0.05	0.06	0.06	0.07	0.08	0.09	0.10	0.13	0.07	0.05	0.05	0.06	0.06	0.07	0.08	0.09	0.13
81 years and older	0.08	0.06	0.06	0.07	0.08	0.09	0.10	0.11	0.12	0.07	0.05	0.06	0.06	0.07	0.08	0.09	0.10	0.12

Table C-5. Descriptive statistics for average ventilation rate (L/min-kg), adjusted for body weight, while performing activities within the specified activity category, by age and gender categories (continued)

Age Category	Average Ventilation Rate (L/min-kg) - Males, Adjusted for Body Weight									Average Ventilation Rate (L/min-kg) - Females, Adjusted for Body Weight								
	Mean	Percentiles							Max	Mean	Percentiles							Max
		5 th	10 th	25 th	50 th	75 th	90 th	95 th			5 th	10 th	25 th	50 th	75 th	90 th	95 th	
Sedentary & Passive Activities (METs ≤ 1.5—Includes Sleep or Nap)																		
Birth to <1 year	0.40	0.30	0.32	0.35	0.39	0.44	0.47	0.50	0.66	0.40	0.30	0.32	0.35	0.40	0.45	0.48	0.52	0.72
1 year	0.41	0.32	0.33	0.36	0.40	0.45	0.49	0.52	0.62	0.43	0.34	0.35	0.38	0.42	0.47	0.51	0.54	0.64
2 years	0.34	0.27	0.29	0.31	0.34	0.37	0.41	0.45	0.51	0.36	0.29	0.30	0.32	0.35	0.39	0.42	0.44	0.48
3 to <6 years	0.25	0.18	0.19	0.21	0.25	0.29	0.33	0.35	0.45	0.25	0.16	0.18	0.21	0.25	0.28	0.33	0.36	0.49
6 to <11 years	0.16	0.11	0.12	0.14	0.16	0.18	0.21	0.22	0.29	0.16	0.10	0.11	0.13	0.16	0.19	0.21	0.23	0.29
11 to <16 years	0.10	0.08	0.08	0.09	0.10	0.12	0.13	0.14	0.20	0.10	0.07	0.07	0.08	0.09	0.11	0.12	0.13	0.17
16 to <21 years	0.08	0.05	0.06	0.07	0.08	0.09	0.09	0.10	0.13	0.07	0.05	0.06	0.06	0.07	0.08	0.10	0.10	0.14
21 to <31 years	0.06	0.05	0.05	0.06	0.06	0.07	0.08	0.08	0.12	0.06	0.04	0.05	0.05	0.06	0.07	0.07	0.08	0.10
31 to <41 years	0.07	0.05	0.05	0.06	0.07	0.07	0.08	0.09	0.12	0.06	0.04	0.04	0.05	0.06	0.07	0.08	0.08	0.11
41 to <51 years	0.07	0.05	0.06	0.06	0.07	0.08	0.09	0.09	0.13	0.06	0.04	0.05	0.05	0.06	0.07	0.08	0.09	0.11
51 to <61 years	0.07	0.05	0.06	0.06	0.07	0.08	0.09	0.09	0.14	0.07	0.05	0.05	0.06	0.07	0.08	0.08	0.09	0.12
61 to <71 years	0.08	0.06	0.06	0.07	0.08	0.08	0.09	0.09	0.11	0.07	0.05	0.05	0.06	0.07	0.07	0.08	0.08	0.10
71 to <81 years	0.08	0.07	0.07	0.08	0.08	0.09	0.09	0.10	0.11	0.07	0.06	0.06	0.07	0.07	0.08	0.09	0.09	0.15
81 years and older	0.09	0.07	0.08	0.08	0.09	0.09	0.10	0.11	0.11	0.08	0.06	0.07	0.07	0.08	0.09	0.09	0.10	0.11

Table C-5. Descriptive statistics for average ventilation rate (L/min-kg), adjusted for body weight, while performing activities within the specified activity category, by age and gender categories (continued)

Age Category	Average Ventilation Rate (L/min-kg) - Males, Adjusted for Body Weight									Average Ventilation Rate (L/min-kg) - Females, Adjusted for Body Weight								
	Mean	Percentiles							Max	Mean	Percentiles							Max
		5 th	10 th	25 th	50 th	75 th	90 th	95 th			5 th	10 th	25 th	50 th	75 th	90 th	95 th	
Light Intensity Activities (1.5 < METS ≤ 3.0)																		
Birth to <1 year	0.99	0.79	0.83	0.90	0.97	1.07	1.17	1.20	1.43	0.98	0.79	0.82	0.88	0.96	1.05	1.18	1.23	1.65
1 year	1.02	0.84	0.86	0.92	1.01	1.10	1.22	1.30	1.48	1.05	0.85	0.87	0.95	1.04	1.14	1.25	1.27	1.64
2 years	0.84	0.68	0.72	0.76	0.83	0.89	1.00	1.03	1.18	0.90	0.73	0.76	0.82	0.89	0.96	1.04	1.10	1.26
3 to <6 years	0.63	0.44	0.48	0.54	0.63	0.71	0.79	0.87	1.08	0.62	0.45	0.48	0.54	0.60	0.70	0.78	0.83	1.02
6 to <11 years	0.38	0.27	0.29	0.32	0.38	0.44	0.49	0.53	0.71	0.38	0.25	0.27	0.31	0.38	0.44	0.50	0.54	0.71
11 to <16 years	0.25	0.18	0.19	0.21	0.24	0.28	0.31	0.33	0.44	0.23	0.16	0.17	0.20	0.22	0.25	0.28	0.31	0.40
16 to <21 years	0.18	0.14	0.14	0.16	0.18	0.20	0.22	0.23	0.33	0.17	0.13	0.14	0.15	0.17	0.19	0.21	0.22	0.29
21 to <31 years	0.16	0.12	0.13	0.14	0.15	0.17	0.19	0.21	0.29	0.15	0.12	0.12	0.13	0.15	0.16	0.18	0.19	0.23
31 to <41 years	0.16	0.12	0.13	0.14	0.16	0.18	0.20	0.21	0.28	0.15	0.11	0.12	0.13	0.15	0.18	0.19	0.20	0.27
41 to <51 years	0.17	0.13	0.13	0.15	0.16	0.18	0.20	0.21	0.33	0.16	0.11	0.12	0.14	0.16	0.18	0.20	0.22	0.28
51 to <61 years	0.17	0.13	0.13	0.15	0.16	0.18	0.20	0.22	0.29	0.16	0.12	0.13	0.14	0.16	0.18	0.20	0.21	0.26
61 to <71 years	0.16	0.14	0.14	0.15	0.16	0.18	0.19	0.20	0.27	0.15	0.12	0.12	0.13	0.14	0.16	0.17	0.18	0.24
71 to <81 years	0.17	0.14	0.15	0.16	0.17	0.18	0.19	0.20	0.26	0.16	0.12	0.13	0.14	0.16	0.17	0.19	0.20	0.28
81 years and older	0.18	0.15	0.16	0.17	0.18	0.20	0.21	0.22	0.25	0.17	0.13	0.14	0.15	0.16	0.18	0.20	0.21	0.23

Table C-5. Descriptive statistics for average ventilation rate (L/min-kg), adjusted for body weight, while performing activities within the specified activity category, by age and gender categories (continued)

Age Category	Average Ventilation Rate (L/min-kg) - Males, Adjusted for Body Weight									Average Ventilation Rate (L/min-kg) - Females, Adjusted for Body Weight								
	Mean	Percentiles							Max	Mean	Percentiles							Max
		5 th	10 th	25 th	50 th	75 th	90 th	95 th			5 th	10 th	25 th	50 th	75 th	90 th	95 th	
Moderate Intensity Activities (3.0 < METS ≤ 6.0)																		
Birth to <1 year	1.80	1.39	1.49	1.62	1.78	1.94	2.18	2.28	3.01	1.87	1.47	1.52	1.67	1.85	2.01	2.25	2.40	2.83
1 year	1.88	1.41	1.50	1.65	1.82	2.01	2.33	2.53	3.23	1.90	1.52	1.62	1.73	1.87	2.02	2.24	2.37	3.24
2 years	1.55	1.21	1.28	1.40	1.54	1.66	1.84	2.02	2.29	1.60	1.27	1.31	1.44	1.58	1.75	1.92	2.02	2.59
3 to <6 years	1.17	0.80	0.88	1.00	1.12	1.31	1.56	1.68	2.10	1.14	0.79	0.85	0.96	1.11	1.31	1.45	1.56	1.93
6 to <11 years	0.74	0.50	0.55	0.62	0.71	0.83	0.96	1.04	1.43	0.72	0.46	0.51	0.60	0.71	0.84	0.94	1.01	1.37
11 to <16 years	0.49	0.36	0.38	0.42	0.47	0.55	0.64	0.68	1.06	0.44	0.32	0.34	0.38	0.43	0.49	0.55	0.61	0.99
16 to <21 years	0.39	0.28	0.30	0.33	0.38	0.43	0.49	0.52	0.71	0.36	0.27	0.28	0.31	0.35	0.41	0.46	0.49	0.65
21 to <31 years	0.36	0.24	0.26	0.30	0.34	0.40	0.47	0.51	0.82	0.33	0.24	0.25	0.28	0.32	0.36	0.42	0.45	0.66
31 to <41 years	0.36	0.24	0.26	0.30	0.34	0.40	0.47	0.52	0.76	0.32	0.21	0.23	0.27	0.30	0.35	0.41	0.46	0.71
41 to <51 years	0.37	0.25	0.27	0.31	0.35	0.41	0.47	0.52	0.72	0.33	0.22	0.24	0.28	0.32	0.38	0.44	0.49	0.62
51 to <61 years	0.38	0.26	0.28	0.31	0.37	0.43	0.48	0.55	0.76	0.34	0.24	0.25	0.28	0.33	0.38	0.44	0.49	0.64
61 to <71 years	0.34	0.27	0.28	0.31	0.34	0.37	0.40	0.42	0.57	0.29	0.22	0.24	0.26	0.28	0.32	0.35	0.37	0.51
71 to <81 years	0.36	0.29	0.31	0.33	0.36	0.39	0.42	0.44	0.55	0.31	0.24	0.25	0.27	0.30	0.34	0.38	0.41	0.68
81 years and older	0.38	0.31	0.32	0.35	0.38	0.42	0.45	0.47	0.53	0.33	0.25	0.27	0.30	0.33	0.37	0.40	0.42	0.52

Table C-5. Descriptive statistics for average ventilation rate (L/min-kg), adjusted for body weight, while performing activities within the specified activity category, by age and gender categories (continued)

Age Category	Average Ventilation Rate (L/min-kg) - Males, Adjusted for Body Weight									Average Ventilation Rate (L/min-kg) - Females, Adjusted for Body Weight									
	Mean	Percentiles							Max	Mean	Percentiles							Max	
		5 th	10 th	25 th	50 th	75 th	90 th	95 th			5 th	10 th	25 th	50 th	75 th	90 th	95 th		
High Intensity (METs > 6.0)																			
Birth to <1 year	3.48	2.70	2.93	3.10	3.46	3.81	4.14	4.32	5.08	3.26	2.53	2.62	2.89	3.23	3.63	3.96	4.08	5.02	
1 year	3.52	2.52	2.89	3.22	3.57	3.91	4.11	4.34	4.86	3.38	2.57	2.75	2.97	3.24	3.71	4.16	4.87	4.88	
2 years	2.89	2.17	2.34	2.58	2.87	3.20	3.43	3.54	4.30	2.80	2.20	2.31	2.48	2.81	3.12	3.35	3.48	3.88	
3 to <6 years	2.17	1.55	1.66	1.81	2.11	2.50	2.73	2.98	3.62	1.98	1.36	1.51	1.69	1.90	2.19	2.50	2.99	3.24	
6 to <11 years	1.41	0.94	1.03	1.19	1.38	1.59	1.83	1.93	2.68	1.33	0.89	0.97	1.12	1.33	1.52	1.72	1.81	2.22	
11 to <16 years	0.95	0.63	0.70	0.79	0.91	1.09	1.27	1.36	1.98	0.88	0.59	0.63	0.71	0.85	1.01	1.18	1.31	2.05	
16 to <21 years	0.71	0.48	0.53	0.60	0.69	0.80	0.92	1.00	1.94	0.70	0.45	0.50	0.57	0.69	0.79	0.92	1.00	1.50	
21 to <31 years	0.66	0.45	0.47	0.54	0.64	0.75	0.85	0.97	1.27	0.65	0.42	0.46	0.55	0.63	0.73	0.88	0.94	1.30	
31 to <41 years	0.64	0.44	0.47	0.53	0.62	0.73	0.85	0.93	1.23	0.61	0.38	0.42	0.50	0.59	0.71	0.83	0.90	1.55	
41 to <51 years	0.66	0.44	0.48	0.55	0.63	0.74	0.86	0.94	1.77	0.65	0.38	0.44	0.52	0.64	0.76	0.88	0.95	1.61	
51 to <61 years	0.68	0.45	0.48	0.55	0.64	0.77	0.91	1.02	1.31	0.63	0.39	0.43	0.51	0.61	0.75	0.85	0.93	1.37	
61 to <71 years	0.62	0.44	0.47	0.53	0.61	0.70	0.79	0.85	1.08	0.54	0.36	0.40	0.45	0.53	0.61	0.72	0.80	1.11	
71 to <81 years	0.65	0.47	0.50	0.55	0.63	0.72	0.85	0.91	1.04	0.59	0.39	0.44	0.50	0.58	0.68	0.78	0.83	1.26	
81 years and older	0.72	0.50	0.54	0.60	0.70	0.80	0.94	0.99	1.35	0.67	0.45	0.48	0.54	0.63	0.77	0.93	0.97	1.22	

Individual measures are weighted by their 4-year sampling weights as assigned within NHANES 1999–2002 when calculating the statistics in this table. Ventilation rate was estimated using the multiple linear regression model in Section 3.6.

Table C-6. Descriptive statistics for daily ventilation rate (m³/min), unadjusted for body weight, while performing activities within the specified activity category, by age and gender categories

Age Category	Daily Ventilation Rate (m ³ /min) - Males, Unadjusted for Body Weight									Daily Ventilation Rate (m ³ /min) - Females, Unadjusted for Body Weight								
	Mean	Percentiles							Max	Mean	Percentiles							Max
		5 th	10 th	25 th	50 th	75 th	90 th	95 th			5 th	10 th	25 th	50 th	75 th	90 th	95 th	
Sleep or nap (Activity ID = 14500)																		
Birth to <1 year	3.1E-03	1.7E-03	1.9E-03	2.5E-03	3.0E-03	3.7E-03	4.4E-03	4.8E-03	7.2E-03	2.9E-03	1.5E-03	1.7E-03	2.3E-03	2.9E-03	3.5E-03	4.0E-03	4.4E-03	8.7E-03
1 year	4.5E-03	3.1E-03	3.3E-03	3.8E-03	4.3E-03	4.9E-03	5.9E-03	6.4E-03	1.0E-02	4.6E-03	3.0E-03	3.3E-03	3.8E-03	4.6E-03	5.3E-03	6.0E-03	6.4E-03	9.6E-03
2 years	4.6E-03	3.0E-03	3.4E-03	3.9E-03	4.5E-03	5.2E-03	6.1E-03	6.7E-03	9.0E-03	4.6E-03	3.0E-03	3.3E-03	4.0E-03	4.5E-03	5.2E-03	5.8E-03	6.1E-03	9.5E-03
3 to <6 years	4.4E-03	3.1E-03	3.3E-03	3.8E-03	4.3E-03	4.9E-03	5.5E-03	5.9E-03	7.7E-03	4.2E-03	2.9E-03	3.2E-03	3.6E-03	4.1E-03	4.7E-03	5.2E-03	5.7E-03	7.4E-03
6 to <11 years	4.6E-03	3.1E-03	3.4E-03	3.8E-03	4.5E-03	5.2E-03	6.0E-03	6.5E-03	9.9E-03	4.4E-03	3.0E-03	3.2E-03	3.7E-03	4.2E-03	4.9E-03	5.7E-03	6.1E-03	8.4E-03
11 to <16 years	5.3E-03	3.5E-03	3.8E-03	4.3E-03	5.1E-03	5.9E-03	6.9E-03	7.8E-03	1.1E-02	4.8E-03	3.3E-03	3.6E-03	4.0E-03	4.7E-03	5.4E-03	6.4E-03	7.0E-03	9.4E-03
16 to <21 years	5.3E-03	3.6E-03	3.9E-03	4.3E-03	5.2E-03	6.1E-03	6.9E-03	7.6E-03	1.3E-02	4.4E-03	2.8E-03	3.0E-03	3.6E-03	4.3E-03	5.1E-03	5.9E-03	6.6E-03	1.2E-02
21 to <31 years	4.7E-03	3.2E-03	3.3E-03	3.8E-03	4.6E-03	5.4E-03	6.3E-03	6.9E-03	1.1E-02	3.9E-03	2.5E-03	2.7E-03	3.1E-03	3.7E-03	4.4E-03	5.4E-03	6.0E-03	9.6E-03
31 to <41 years	5.2E-03	3.4E-03	3.6E-03	4.2E-03	5.0E-03	5.8E-03	6.8E-03	7.5E-03	1.1E-02	4.0E-03	2.7E-03	2.9E-03	3.3E-03	3.9E-03	4.5E-03	5.3E-03	5.8E-03	8.1E-03
41 to <51 years	5.7E-03	3.7E-03	4.1E-03	4.7E-03	5.5E-03	6.5E-03	7.4E-03	7.8E-03	1.1E-02	4.4E-03	3.0E-03	3.2E-03	3.7E-03	4.2E-03	5.0E-03	5.7E-03	6.2E-03	9.0E-03
51 to <61 years	5.8E-03	4.0E-03	4.2E-03	4.8E-03	5.6E-03	6.5E-03	7.7E-03	8.3E-03	1.2E-02	4.6E-03	3.1E-03	3.3E-03	3.7E-03	4.4E-03	5.2E-03	6.1E-03	6.6E-03	9.0E-03
61 to <71 years	6.0E-03	4.4E-03	4.6E-03	5.1E-03	5.8E-03	6.7E-03	7.5E-03	7.9E-03	1.2E-02	4.5E-03	3.2E-03	3.3E-03	3.8E-03	4.4E-03	5.0E-03	5.7E-03	6.4E-03	9.6E-03
71 to <81 years	6.1E-03	4.3E-03	4.6E-03	5.2E-03	6.0E-03	6.8E-03	7.6E-03	8.3E-03	1.1E-02	4.5E-03	3.3E-03	3.5E-03	3.9E-03	4.4E-03	5.1E-03	5.7E-03	6.1E-03	7.3E-03
81 years and older	6.0E-03	4.2E-03	4.5E-03	5.2E-03	5.9E-03	6.7E-03	7.4E-03	7.8E-03	1.0E-02	4.5E-03	3.2E-03	3.5E-03	3.8E-03	4.4E-03	4.9E-03	5.6E-03	6.2E-03	8.3E-03

Table C-6. Descriptive statistics for daily ventilation rate (m³/min), unadjusted for body weight, while performing activities within the specified activity category, by age and gender categories (continued)

Age Category	Daily Ventilation Rate (m ³ /min) - Males, Unadjusted for Body Weight									Daily Ventilation Rate (m ³ /min) - Females, Unadjusted for Body Weight								
	Mean	Percentiles							Max	Mean	Percentiles							Max
		5 th	10 th	25 th	50 th	75 th	90 th	95 th			5 th	10 th	25 th	50 th	75 th	90 th	95 th	
Sedentary & Passive Activities (METs ≤ 1.5—Includes Sleep or Nap)																		
Birth to <1 year	3.2E-03	1.7E-03	2.0E-03	2.5E-03	3.1E-03	3.8E-03	4.4E-03	4.9E-03	7.1E-03	3.0E-03	1.6E-03	1.8E-03	2.3E-03	3.0E-03	3.6E-03	4.1E-03	4.4E-03	9.6E-03
1 year	4.6E-03	3.2E-03	3.5E-03	3.9E-03	4.5E-03	5.0E-03	6.0E-03	6.4E-03	9.9E-03	4.7E-03	3.3E-03	3.4E-03	4.0E-03	4.7E-03	5.3E-03	6.0E-03	6.6E-03	9.5E-03
2 years	4.8E-03	3.2E-03	3.7E-03	4.1E-03	4.7E-03	5.4E-03	6.1E-03	6.7E-03	9.1E-03	4.7E-03	3.3E-03	3.5E-03	4.2E-03	4.7E-03	5.3E-03	5.8E-03	6.2E-03	9.4E-03
3 to <6 years	4.6E-03	3.5E-03	3.6E-03	4.1E-03	4.6E-03	5.0E-03	5.6E-03	5.8E-03	7.6E-03	4.4E-03	3.3E-03	3.5E-03	3.9E-03	4.3E-03	4.8E-03	5.3E-03	5.7E-03	7.1E-03
6 to <11 years	4.9E-03	3.6E-03	3.8E-03	4.2E-03	4.7E-03	5.4E-03	6.0E-03	6.6E-03	9.5E-03	4.6E-03	3.4E-03	3.7E-03	4.0E-03	4.5E-03	5.1E-03	5.9E-03	6.3E-03	8.3E-03
11 to <16 years	5.6E-03	4.0E-03	4.3E-03	4.8E-03	5.4E-03	6.3E-03	7.2E-03	7.9E-03	1.1E-02	5.2E-03	3.9E-03	4.2E-03	4.5E-03	5.1E-03	5.7E-03	6.5E-03	7.1E-03	9.1E-03
16 to <21 years	5.8E-03	4.2E-03	4.4E-03	4.9E-03	5.6E-03	6.4E-03	7.1E-03	7.8E-03	1.3E-02	4.8E-03	3.3E-03	3.6E-03	4.0E-03	4.7E-03	5.3E-03	6.0E-03	6.6E-03	1.2E-02
21 to <31 years	5.1E-03	3.8E-03	4.0E-03	4.3E-03	5.0E-03	5.6E-03	6.4E-03	7.0E-03	1.0E-02	4.2E-03	3.0E-03	3.2E-03	3.6E-03	4.0E-03	4.6E-03	5.4E-03	6.0E-03	9.2E-03
31 to <41 years	5.6E-03	4.0E-03	4.4E-03	4.9E-03	5.4E-03	6.2E-03	7.0E-03	7.4E-03	1.0E-02	4.3E-03	3.2E-03	3.4E-03	3.8E-03	4.2E-03	4.8E-03	5.3E-03	5.8E-03	7.7E-03
41 to <51 years	6.1E-03	4.7E-03	4.9E-03	5.4E-03	6.0E-03	6.7E-03	7.5E-03	7.8E-03	1.1E-02	4.8E-03	3.6E-03	3.8E-03	4.2E-03	4.6E-03	5.2E-03	5.7E-03	6.3E-03	8.7E-03
51 to <61 years	6.3E-03	4.7E-03	5.1E-03	5.5E-03	6.2E-03	6.9E-03	7.6E-03	8.1E-03	1.0E-02	5.0E-03	3.8E-03	4.0E-03	4.4E-03	4.9E-03	5.4E-03	6.1E-03	6.4E-03	8.3E-03
61 to <71 years	6.5E-03	5.0E-03	5.3E-03	5.8E-03	6.5E-03	7.1E-03	7.9E-03	8.2E-03	1.1E-02	4.9E-03	3.8E-03	4.0E-03	4.3E-03	4.8E-03	5.3E-03	5.9E-03	6.3E-03	8.2E-03
71 to <81 years	6.6E-03	5.3E-03	5.6E-03	6.0E-03	6.6E-03	7.2E-03	7.8E-03	8.3E-03	9.9E-03	4.9E-03	4.1E-03	4.1E-03	4.4E-03	4.9E-03	5.4E-03	5.9E-03	6.1E-03	7.6E-03
81 years and older	6.4E-03	5.1E-03	5.4E-03	5.8E-03	6.4E-03	7.0E-03	7.6E-03	7.9E-03	9.1E-03	4.9E-03	3.9E-03	4.1E-03	4.4E-03	4.8E-03	5.3E-03	5.7E-03	6.1E-03	7.5E-03

Table C-6. Descriptive statistics for daily ventilation rate (m³/min), unadjusted for body weight, while performing activities within the specified activity category, by age and gender categories (continued)

Age Category	Daily Ventilation Rate (m ³ /min) - Males, Unadjusted for Body Weight									Daily Ventilation Rate (m ³ /min) - Females, Unadjusted for Body Weight								
	Mean	Percentiles							Max	Mean	Percentiles							Max
		5 th	10 th	25 th	50 th	75 th	90 th	95 th			5 th	10 th	25 th	50 th	75 th	90 th	95 th	
Light Intensity Activities (1.5 < METS ≤ 3.0)																		
Birth to <1 year	7.9E-03	4.1E-03	5.1E-03	6.2E-03	7.9E-03	9.6E-03	1.1E-02	1.2E-02	1.5E-02	7.3E-03	3.8E-03	4.6E-03	5.7E-03	7.2E-03	8.7E-03	9.8E-03	1.1E-02	1.7E-02
1 year	1.2E-02	8.7E-03	9.0E-03	9.9E-03	1.1E-02	1.3E-02	1.4E-02	1.6E-02	2.1E-02	1.2E-02	8.6E-03	8.8E-03	1.0E-02	1.1E-02	1.3E-02	1.5E-02	1.6E-02	2.0E-02
2 years	1.2E-02	8.5E-03	9.1E-03	1.0E-02	1.1E-02	1.3E-02	1.5E-02	1.5E-02	1.9E-02	1.2E-02	8.7E-03	9.4E-03	1.0E-02	1.2E-02	1.3E-02	1.6E-02	1.6E-02	2.4E-02
3 to <6 years	1.1E-02	9.2E-03	9.5E-03	1.0E-02	1.1E-02	1.2E-02	1.3E-02	1.4E-02	2.0E-02	1.1E-02	8.8E-03	9.0E-03	9.9E-03	1.1E-02	1.2E-02	1.3E-02	1.4E-02	1.6E-02
6 to <11 years	1.2E-02	9.0E-03	9.3E-03	1.0E-02	1.1E-02	1.3E-02	1.5E-02	1.6E-02	2.2E-02	1.1E-02	8.5E-03	9.0E-03	9.8E-03	1.1E-02	1.2E-02	1.3E-02	1.5E-02	2.2E-02
11 to <16 years	1.3E-02	9.8E-03	1.0E-02	1.1E-02	1.3E-02	1.5E-02	1.6E-02	1.9E-02	2.7E-02	1.2E-02	9.4E-03	9.7E-03	1.1E-02	1.2E-02	1.3E-02	1.5E-02	1.6E-02	2.2E-02
16 to <21 years	1.3E-02	1.0E-02	1.1E-02	1.2E-02	1.3E-02	1.5E-02	1.7E-02	1.8E-02	2.9E-02	1.1E-02	8.3E-03	8.7E-03	9.6E-03	1.1E-02	1.2E-02	1.4E-02	1.5E-02	2.1E-02
21 to <31 years	1.3E-02	9.7E-03	1.0E-02	1.1E-02	1.2E-02	1.4E-02	1.6E-02	1.8E-02	2.7E-02	1.1E-02	7.8E-03	8.2E-03	9.1E-03	1.0E-02	1.2E-02	1.3E-02	1.4E-02	2.1E-02
31 to <41 years	1.4E-02	1.1E-02	1.1E-02	1.2E-02	1.3E-02	1.5E-02	1.6E-02	1.8E-02	2.5E-02	1.1E-02	8.8E-03	9.3E-03	1.0E-02	1.1E-02	1.2E-02	1.3E-02	1.4E-02	1.7E-02
41 to <51 years	1.4E-02	1.1E-02	1.2E-02	1.3E-02	1.4E-02	1.6E-02	1.7E-02	1.8E-02	2.3E-02	1.2E-02	9.6E-03	1.0E-02	1.1E-02	1.2E-02	1.3E-02	1.4E-02	1.5E-02	1.8E-02
51 to <61 years	1.5E-02	1.1E-02	1.2E-02	1.3E-02	1.4E-02	1.6E-02	1.8E-02	1.9E-02	2.5E-02	1.2E-02	9.8E-03	1.0E-02	1.1E-02	1.2E-02	1.3E-02	1.4E-02	1.5E-02	1.8E-02
61 to <71 years	1.4E-02	1.1E-02	1.2E-02	1.3E-02	1.4E-02	1.5E-02	1.7E-02	1.8E-02	2.1E-02	1.1E-02	8.9E-03	9.3E-03	9.8E-03	1.1E-02	1.2E-02	1.3E-02	1.3E-02	1.7E-02
71 to <81 years	1.4E-02	1.1E-02	1.2E-02	1.3E-02	1.4E-02	1.5E-02	1.6E-02	1.7E-02	2.0E-02	1.1E-02	8.8E-03	9.2E-03	9.9E-03	1.1E-02	1.2E-02	1.3E-02	1.3E-02	1.8E-02
81 years and older	1.4E-02	1.1E-02	1.2E-02	1.3E-02	1.4E-02	1.5E-02	1.6E-02	1.7E-02	2.1E-02	1.0E-02	8.7E-03	8.8E-03	9.4E-03	1.0E-02	1.1E-02	1.2E-02	1.3E-02	1.6E-02

Table C-6. Descriptive statistics for daily ventilation rate (m³/min), unadjusted for body weight, while performing activities within the specified activity category, by age and gender categories (continued)

Age Category	Daily Ventilation Rate (m ³ /min) - Males, Unadjusted for Body Weight									Daily Ventilation Rate (m ³ /min) - Females, Unadjusted for Body Weight								
	Mean	Percentiles							Max	Mean	Percentiles							Max
		5 th	10 th	25 th	50 th	75 th	90 th	95 th			5 th	10 th	25 th	50 th	75 th	90 th	95 th	
Moderate Intensity Activities (3.0 < METS ≤ 6.0)																		
Birth to <1 year	1.4E-02	7.4E-03	8.8E-03	1.1E-02	1.4E-02	1.7E-02	2.0E-02	2.3E-02	3.1E-02	1.4E-02	7.9E-03	9.0E-03	1.1E-02	1.4E-02	1.6E-02	1.9E-02	2.2E-02	4.1E-02
1 year	2.1E-02	1.4E-02	1.6E-02	1.8E-02	2.1E-02	2.4E-02	2.7E-02	2.9E-02	4.0E-02	2.1E-02	1.6E-02	1.6E-02	1.8E-02	2.0E-02	2.4E-02	2.7E-02	2.9E-02	3.5E-02
2 years	2.2E-02	1.5E-02	1.7E-02	1.8E-02	2.1E-02	2.4E-02	2.7E-02	3.0E-02	5.1E-02	2.1E-02	1.4E-02	1.6E-02	1.8E-02	2.1E-02	2.4E-02	2.8E-02	2.9E-02	3.8E-02
3 to <6 years	2.1E-02	1.6E-02	1.7E-02	1.9E-02	2.1E-02	2.3E-02	2.6E-02	2.7E-02	3.5E-02	2.0E-02	1.5E-02	1.6E-02	1.8E-02	2.0E-02	2.2E-02	2.4E-02	2.6E-02	3.3E-02
6 to <11 years	2.2E-02	1.6E-02	1.7E-02	1.9E-02	2.2E-02	2.5E-02	2.8E-02	2.9E-02	4.3E-02	2.1E-02	1.6E-02	1.7E-02	1.8E-02	2.0E-02	2.3E-02	2.6E-02	2.8E-02	4.3E-02
11 to <16 years	2.6E-02	1.9E-02	2.0E-02	2.3E-02	2.5E-02	2.9E-02	3.4E-02	3.7E-02	5.5E-02	2.4E-02	1.8E-02	1.9E-02	2.1E-02	2.3E-02	2.5E-02	2.8E-02	3.1E-02	4.2E-02
16 to <21 years	2.9E-02	2.0E-02	2.2E-02	2.5E-02	2.8E-02	3.2E-02	3.8E-02	4.2E-02	6.7E-02	2.3E-02	1.7E-02	1.8E-02	2.0E-02	2.2E-02	2.6E-02	3.0E-02	3.2E-02	5.2E-02
21 to <31 years	2.9E-02	2.0E-02	2.1E-02	2.4E-02	2.8E-02	3.3E-02	3.9E-02	4.3E-02	7.2E-02	2.3E-02	1.6E-02	1.7E-02	1.9E-02	2.2E-02	2.6E-02	3.0E-02	3.3E-02	5.4E-02
31 to <41 years	3.0E-02	2.1E-02	2.3E-02	2.5E-02	2.9E-02	3.4E-02	4.0E-02	4.3E-02	5.8E-02	2.3E-02	1.7E-02	1.8E-02	1.9E-02	2.2E-02	2.5E-02	2.9E-02	3.1E-02	4.7E-02
41 to <51 years	3.2E-02	2.3E-02	2.4E-02	2.7E-02	3.0E-02	3.5E-02	4.0E-02	4.5E-02	6.3E-02	2.4E-02	1.8E-02	1.9E-02	2.1E-02	2.4E-02	2.7E-02	3.1E-02	3.4E-02	5.1E-02
51 to <61 years	3.3E-02	2.2E-02	2.4E-02	2.8E-02	3.1E-02	3.7E-02	4.2E-02	4.6E-02	7.0E-02	2.5E-02	1.9E-02	2.0E-02	2.2E-02	2.4E-02	2.8E-02	3.2E-02	3.5E-02	4.6E-02
61 to <71 years	3.0E-02	2.2E-02	2.4E-02	2.6E-02	2.9E-02	3.2E-02	3.7E-02	4.0E-02	5.2E-02	2.1E-02	1.7E-02	1.8E-02	1.9E-02	2.1E-02	2.3E-02	2.6E-02	2.7E-02	3.5E-02
71 to <81 years	2.9E-02	2.3E-02	2.4E-02	2.6E-02	2.9E-02	3.2E-02	3.6E-02	3.7E-02	4.5E-02	2.1E-02	1.7E-02	1.8E-02	1.9E-02	2.1E-02	2.3E-02	2.5E-02	2.6E-02	3.4E-02
81 years and older	2.9E-02	2.2E-02	2.3E-02	2.5E-02	2.8E-02	3.1E-02	3.3E-02	3.6E-02	4.1E-02	2.1E-02	1.7E-02	1.8E-02	1.9E-02	2.1E-02	2.3E-02	2.5E-02	2.6E-02	2.9E-02

Table C-6. Descriptive statistics for daily ventilation rate (m³/min), unadjusted for body weight, while performing activities within the specified activity category, by age and gender categories (continued)

Age Category	Daily Ventilation Rate (m ³ /min) - Males, Unadjusted for Body Weight									Daily Ventilation Rate (m ³ /min) - Females, Unadjusted for Body Weight								
	Mean	Percentiles							Max	Mean	Percentiles							Max
		5 th	10 th	25 th	50 th	75 th	90 th	95 th			5 th	10 th	25 th	50 th	75 th	90 th	95 th	
High Intensity (METS > 6.0)																		
Birth to <1 year	2.7E-02	1.5E-02	1.7E-02	2.1E-02	2.8E-02	3.2E-02	3.8E-02	4.2E-02	5.8E-02	2.4E-02	1.2E-02	1.3E-02	1.7E-02	2.2E-02	2.9E-02	3.6E-02	4.1E-02	7.5E-02
1 year	4.0E-02	2.8E-02	3.2E-02	3.5E-02	4.0E-02	4.4E-02	5.2E-02	5.6E-02	6.1E-02	3.6E-02	2.6E-02	2.6E-02	3.0E-02	3.6E-02	4.2E-02	4.7E-02	4.9E-02	7.7E-02
2 years	4.0E-02	2.8E-02	3.0E-02	3.4E-02	4.1E-02	4.6E-02	5.2E-02	5.5E-02	9.2E-02	3.8E-02	2.9E-02	3.1E-02	3.2E-02	3.6E-02	4.1E-02	4.8E-02	5.1E-02	7.3E-02
3 to <6 years	3.9E-02	2.9E-02	3.1E-02	3.4E-02	3.8E-02	4.3E-02	4.9E-02	5.2E-02	6.6E-02	3.5E-02	2.7E-02	2.8E-02	3.0E-02	3.3E-02	3.8E-02	4.3E-02	4.5E-02	5.7E-02
6 to <11 years	4.4E-02	3.1E-02	3.3E-02	3.6E-02	4.2E-02	5.0E-02	5.7E-02	6.2E-02	9.0E-02	3.9E-02	2.9E-02	3.0E-02	3.4E-02	3.8E-02	4.4E-02	5.0E-02	5.5E-02	8.3E-02
11 to <16 years	5.1E-02	3.4E-02	3.7E-02	4.2E-02	4.9E-02	5.7E-02	6.6E-02	7.3E-02	1.2E-01	4.7E-02	3.1E-02	3.4E-02	3.9E-02	4.5E-02	5.3E-02	6.1E-02	6.6E-02	1.0E-01
16 to <21 years	5.3E-02	3.6E-02	3.8E-02	4.4E-02	5.1E-02	5.9E-02	7.1E-02	8.3E-02	1.3E-01	4.4E-02	2.9E-02	3.1E-02	3.7E-02	4.3E-02	5.0E-02	5.8E-02	6.3E-02	1.1E-01
21 to <31 years	5.4E-02	3.4E-02	3.8E-02	4.5E-02	5.2E-02	6.2E-02	7.2E-02	8.2E-02	1.1E-01	4.6E-02	2.9E-02	3.1E-02	3.7E-02	4.3E-02	5.2E-02	6.2E-02	6.9E-02	1.1E-01
31 to <41 years	5.4E-02	3.8E-02	4.0E-02	4.5E-02	5.2E-02	6.1E-02	7.1E-02	7.7E-02	1.0E-01	4.4E-02	3.0E-02	3.3E-02	3.7E-02	4.2E-02	5.0E-02	6.0E-02	6.5E-02	9.0E-02
41 to <51 years	5.7E-02	3.8E-02	4.2E-02	4.8E-02	5.5E-02	6.4E-02	7.6E-02	8.4E-02	1.1E-01	4.7E-02	3.1E-02	3.4E-02	3.8E-02	4.6E-02	5.4E-02	6.2E-02	6.7E-02	8.9E-02
51 to <61 years	5.8E-02	3.9E-02	4.2E-02	4.9E-02	5.6E-02	6.6E-02	7.9E-02	8.6E-02	1.4E-01	4.7E-02	3.2E-02	3.5E-02	3.9E-02	4.6E-02	5.4E-02	6.2E-02	6.9E-02	8.4E-02
61 to <71 years	5.4E-02	3.6E-02	4.0E-02	4.5E-02	5.2E-02	6.1E-02	7.2E-02	7.5E-02	1.0E-01	4.0E-02	2.8E-02	3.1E-02	3.5E-02	3.9E-02	4.5E-02	5.1E-02	5.6E-02	7.1E-02
71 to <81 years	5.2E-02	3.7E-02	4.0E-02	4.4E-02	5.0E-02	5.9E-02	6.8E-02	7.6E-02	9.7E-02	4.1E-02	2.8E-02	3.0E-02	3.4E-02	4.0E-02	4.7E-02	5.2E-02	5.4E-02	7.5E-02
81 years and older	5.3E-02	3.5E-02	3.9E-02	4.6E-02	5.1E-02	6.1E-02	7.0E-02	7.7E-02	9.7E-02	4.2E-02	2.8E-02	3.0E-02	3.4E-02	4.1E-02	4.8E-02	5.6E-02	5.8E-02	7.2E-02

C-26

Individual measures are weighted by their 4-year sampling weights as assigned within NHANES 1999–2002 when calculating the statistics in this table. Ventilation rate was estimated using the multiple linear regression model in Section 3.6.

Table C-7. Descriptive statistics for daily ventilation rate (m³/min-kg), adjusted for body weight, while performing activities within the specified activity category, by age and gender categories

Age Category	Daily Ventilation Rate (m ³ /min-kg) - Males, Adjusted for Body Weight									Daily Ventilation Rate (m ³ /min-kg) - Females, Adjusted for Body Weight								
	Mean	Percentiles							Max	Mean	Percentiles							Max
		5 th	10 th	25 th	50 th	75 th	90 th	95 th			5 th	10 th	25 th	50 th	75 th	90 th	95 th	
Sleep or nap (Activity ID = 14500)																		
Birth to <1 year	3.8E-04	2.8E-04	3.0E-04	3.4E-04	3.8E-04	4.3E-04	4.6E-04	5.0E-04	6.7E-04	3.9E-04	2.8E-04	3.0E-04	3.4E-04	3.9E-04	4.3E-04	4.8E-04	5.2E-04	7.4E-04
1 year	4.0E-04	3.0E-04	3.1E-04	3.5E-04	3.8E-04	4.4E-04	4.9E-04	5.2E-04	6.3E-04	4.1E-04	3.1E-04	3.3E-04	3.6E-04	4.1E-04	4.6E-04	5.2E-04	5.4E-04	6.6E-04
2 years	3.3E-04	2.5E-04	2.6E-04	2.9E-04	3.3E-04	3.6E-04	4.0E-04	4.4E-04	5.4E-04	3.4E-04	2.6E-04	2.7E-04	2.9E-04	3.3E-04	3.9E-04	4.3E-04	4.5E-04	4.9E-04
3 to <6 years	2.4E-04	1.6E-04	1.7E-04	2.0E-04	2.4E-04	2.8E-04	3.1E-04	3.5E-04	4.8E-04	2.4E-04	1.4E-04	1.6E-04	2.0E-04	2.3E-04	2.8E-04	3.2E-04	3.5E-04	5.2E-04
6 to <11 years	1.5E-04	1.0E-04	1.1E-04	1.3E-04	1.5E-04	1.7E-04	2.0E-04	2.2E-04	3.0E-04	1.5E-04	8.9E-05	9.7E-05	1.2E-04	1.5E-04	1.8E-04	2.1E-04	2.3E-04	3.0E-04
11 to <16 years	9.8E-05	6.7E-05	7.2E-05	8.1E-05	9.4E-05	1.1E-04	1.3E-04	1.4E-04	2.1E-04	9.0E-05	5.9E-05	6.5E-05	7.5E-05	8.7E-05	1.0E-04	1.2E-04	1.3E-04	1.8E-04
16 to <21 years	7.1E-05	4.7E-05	5.2E-05	6.1E-05	6.9E-05	8.0E-05	9.0E-05	9.8E-05	1.5E-04	6.9E-05	4.4E-05	4.7E-05	5.7E-05	6.7E-05	8.0E-05	9.3E-05	1.0E-04	1.5E-04
21 to <31 years	5.8E-05	3.8E-05	4.2E-05	4.8E-05	5.6E-05	6.6E-05	7.6E-05	8.3E-05	1.3E-04	5.5E-05	3.5E-05	3.8E-05	4.5E-05	5.4E-05	6.5E-05	7.4E-05	8.2E-05	9.8E-05
31 to <41 years	6.1E-05	3.8E-05	4.3E-05	5.0E-05	6.0E-05	7.0E-05	8.0E-05	8.6E-05	1.3E-04	5.6E-05	3.4E-05	3.7E-05	4.5E-05	5.4E-05	6.5E-05	7.6E-05	8.2E-05	1.1E-04
41 to <51 years	6.5E-05	4.4E-05	4.7E-05	5.4E-05	6.4E-05	7.4E-05	8.6E-05	9.2E-05	1.4E-04	6.0E-05	3.9E-05	4.1E-05	4.8E-05	5.7E-05	7.0E-05	8.4E-05	9.0E-05	1.1E-04
51 to <61 years	6.6E-05	4.5E-05	4.9E-05	5.5E-05	6.4E-05	7.6E-05	8.6E-05	9.3E-05	1.4E-04	6.1E-05	3.9E-05	4.2E-05	5.0E-05	5.9E-05	7.1E-05	8.3E-05	8.8E-05	1.3E-04
61 to <71 years	6.9E-05	5.1E-05	5.4E-05	6.0E-05	6.8E-05	7.6E-05	8.6E-05	9.3E-05	1.2E-04	6.1E-05	4.3E-05	4.6E-05	5.2E-05	5.9E-05	6.7E-05	7.6E-05	8.1E-05	1.0E-04
71 to <81 years	7.5E-05	5.5E-05	5.8E-05	6.4E-05	7.3E-05	8.3E-05	9.3E-05	9.9E-05	1.3E-04	6.6E-05	4.7E-05	5.1E-05	5.6E-05	6.4E-05	7.4E-05	8.4E-05	9.0E-05	1.3E-04
81 years and older	8.0E-05	6.1E-05	6.4E-05	7.1E-05	7.8E-05	8.8E-05	9.7E-05	1.1E-04	1.2E-04	7.2E-05	5.1E-05	5.6E-05	6.3E-05	7.0E-05	7.9E-05	9.1E-05	9.6E-05	1.2E-04

Table C-7. Descriptive statistics for daily ventilation rate (m³/min-kg), adjusted for body weight, while performing activities within the specified activity category, by age and gender categories (continued)

Age Category	Daily Ventilation Rate (m ³ /min-kg) - Males, Adjusted for Body Weight									Daily Ventilation Rate (m ³ /min-kg) - Females, Adjusted for Body Weight								
	Mean	Percentiles							Max	Mean	Percentiles							Max
		5 th	10 th	25 th	50 th	75 th	90 th	95 th			5 th	10 th	25 th	50 th	75 th	90 th	95 th	
Sedentary & Passive Activities (METs ≤ 1.5—Includes Sleep or Nap)																		
Birth to <1 year	4.0E-04	3.0E-04	3.2E-04	3.5E-04	3.9E-04	4.4E-04	4.7E-04	5.0E-04	6.6E-04	4.0E-04	3.0E-04	3.2E-04	3.5E-04	4.0E-04	4.5E-04	4.8E-04	5.2E-04	7.2E-04
1 year	4.1E-04	3.2E-04	3.3E-04	3.6E-04	4.0E-04	4.5E-04	4.9E-04	5.2E-04	6.2E-04	4.3E-04	3.4E-04	3.5E-04	3.8E-04	4.2E-04	4.7E-04	5.1E-04	5.4E-04	6.4E-04
2 years	3.4E-04	2.7E-04	2.9E-04	3.1E-04	3.4E-04	3.7E-04	4.1E-04	4.5E-04	5.1E-04	3.6E-04	2.9E-04	3.0E-04	3.2E-04	3.5E-04	3.9E-04	4.2E-04	4.4E-04	4.8E-04
3 to <6 years	2.5E-04	1.8E-04	1.9E-04	2.1E-04	2.5E-04	2.9E-04	3.3E-04	3.5E-04	4.5E-04	2.5E-04	1.6E-04	1.8E-04	2.1E-04	2.5E-04	2.8E-04	3.3E-04	3.6E-04	4.9E-04
6 to <11 years	1.6E-04	1.1E-04	1.2E-04	1.4E-04	1.6E-04	1.8E-04	2.1E-04	2.2E-04	2.9E-04	1.6E-04	9.9E-05	1.1E-04	1.3E-04	1.6E-04	1.9E-04	2.1E-04	2.3E-04	2.9E-04
11 to <16 years	1.0E-04	7.7E-05	8.0E-05	8.8E-05	1.0E-04	1.2E-04	1.3E-04	1.4E-04	2.0E-04	9.7E-05	7.1E-05	7.5E-05	8.3E-05	9.5E-05	1.1E-04	1.2E-04	1.3E-04	1.7E-04
16 to <21 years	7.7E-05	5.5E-05	6.0E-05	6.8E-05	7.6E-05	8.5E-05	9.5E-05	1.0E-04	1.3E-04	7.5E-05	5.3E-05	5.7E-05	6.3E-05	7.4E-05	8.5E-05	9.6E-05	1.0E-04	1.4E-04
21 to <31 years	6.2E-05	4.7E-05	4.9E-05	5.5E-05	6.1E-05	6.9E-05	7.7E-05	8.2E-05	1.2E-04	6.0E-05	4.3E-05	4.5E-05	5.1E-05	5.9E-05	6.7E-05	7.5E-05	8.0E-05	9.9E-05
31 to <41 years	6.6E-05	4.6E-05	5.0E-05	5.7E-05	6.5E-05	7.4E-05	8.2E-05	8.6E-05	1.2E-04	6.0E-05	4.0E-05	4.2E-05	5.1E-05	5.9E-05	6.9E-05	7.8E-05	8.3E-05	1.1E-04
41 to <51 years	7.1E-05	5.4E-05	5.7E-05	6.2E-05	7.0E-05	7.8E-05	8.6E-05	9.1E-05	1.3E-04	6.5E-05	4.4E-05	4.8E-05	5.5E-05	6.3E-05	7.3E-05	8.3E-05	9.1E-05	1.1E-04
51 to <61 years	7.2E-05	5.5E-05	5.8E-05	6.3E-05	7.1E-05	7.9E-05	8.8E-05	9.2E-05	1.4E-04	6.7E-05	4.6E-05	5.1E-05	5.7E-05	6.5E-05	7.6E-05	8.3E-05	9.0E-05	1.2E-04
61 to <71 years	7.6E-05	6.1E-05	6.4E-05	6.9E-05	7.5E-05	8.1E-05	8.9E-05	9.4E-05	1.1E-04	6.6E-05	5.2E-05	5.4E-05	5.9E-05	6.6E-05	7.2E-05	7.8E-05	8.4E-05	1.0E-04
71 to <81 years	8.2E-05	6.7E-05	7.0E-05	7.5E-05	8.1E-05	8.8E-05	9.4E-05	9.8E-05	1.1E-04	7.2E-05	5.5E-05	6.0E-05	6.5E-05	7.1E-05	7.8E-05	8.8E-05	9.2E-05	1.5E-04
81 years and older	8.6E-05	7.1E-05	7.5E-05	8.0E-05	8.6E-05	9.2E-05	9.9E-05	1.1E-04	1.1E-04	7.8E-05	6.3E-05	6.5E-05	7.0E-05	7.7E-05	8.6E-05	9.3E-05	9.6E-05	1.1E-04

Table C-7. Descriptive statistics for daily ventilation rate (m³/min-kg), adjusted for body weight, while performing activities within the specified activity category, by age and gender categories (continued)

Age Category	Daily Ventilation Rate (m ³ /min-kg) - Males, Adjusted for Body Weight									Daily Ventilation Rate (m ³ /min-kg) - Females, Adjusted for Body Weight								
	Mean	Percentiles							Max	Mean	Percentiles							Max
		5 th	10 th	25 th	50 th	75 th	90 th	95 th			5 th	10 th	25 th	50 th	75 th	90 th	95 th	
Light Intensity Activities (1.5 < METS ≤ 3.0)																		
Birth to <1 year	9.9E-04	7.9E-04	8.3E-04	9.0E-04	9.7E-04	1.1E-03	1.2E-03	1.2E-03	1.4E-03	9.8E-04	7.9E-04	8.2E-04	8.8E-04	9.6E-04	1.0E-03	1.2E-03	1.2E-03	1.7E-03
1 year	1.0E-03	8.4E-04	8.6E-04	9.2E-04	1.0E-03	1.1E-03	1.2E-03	1.3E-03	1.5E-03	1.0E-03	8.5E-04	8.7E-04	9.5E-04	1.0E-03	1.1E-03	1.2E-03	1.3E-03	1.6E-03
2 years	8.4E-04	6.8E-04	7.2E-04	7.6E-04	8.3E-04	8.9E-04	1.0E-03	1.0E-03	1.2E-03	9.0E-04	7.3E-04	7.6E-04	8.2E-04	8.9E-04	9.6E-04	1.0E-03	1.1E-03	1.3E-03
3 to <6 years	6.3E-04	4.4E-04	4.8E-04	5.4E-04	6.3E-04	7.1E-04	7.9E-04	8.7E-04	1.1E-03	6.2E-04	4.5E-04	4.8E-04	5.4E-04	6.0E-04	7.0E-04	7.8E-04	8.3E-04	1.0E-03
6 to <11 years	3.8E-04	2.7E-04	2.9E-04	3.2E-04	3.8E-04	4.4E-04	4.9E-04	5.3E-04	7.1E-04	3.8E-04	2.5E-04	2.7E-04	3.1E-04	3.8E-04	4.4E-04	5.0E-04	5.4E-04	7.1E-04
11 to <16 years	2.5E-04	1.8E-04	1.9E-04	2.1E-04	2.4E-04	2.8E-04	3.1E-04	3.3E-04	4.4E-04	2.3E-04	1.6E-04	1.7E-04	2.0E-04	2.2E-04	2.5E-04	2.8E-04	3.1E-04	4.0E-04
16 to <21 years	1.8E-04	1.4E-04	1.4E-04	1.6E-04	1.8E-04	2.0E-04	2.2E-04	2.3E-04	3.3E-04	1.7E-04	1.3E-04	1.4E-04	1.5E-04	1.7E-04	1.9E-04	2.1E-04	2.2E-04	2.9E-04
21 to <31 years	1.6E-04	1.2E-04	1.3E-04	1.4E-04	1.5E-04	1.7E-04	1.9E-04	2.1E-04	2.9E-04	1.5E-04	1.2E-04	1.2E-04	1.3E-04	1.5E-04	1.6E-04	1.8E-04	1.9E-04	2.3E-04
31 to <41 years	1.6E-04	1.2E-04	1.3E-04	1.4E-04	1.6E-04	1.8E-04	2.0E-04	2.1E-04	2.8E-04	1.5E-04	1.1E-04	1.2E-04	1.3E-04	1.5E-04	1.8E-04	1.9E-04	2.0E-04	2.7E-04
41 to <51 years	1.7E-04	1.3E-04	1.3E-04	1.5E-04	1.6E-04	1.8E-04	2.0E-04	2.1E-04	3.3E-04	1.6E-04	1.1E-04	1.2E-04	1.4E-04	1.6E-04	1.8E-04	2.0E-04	2.2E-04	2.8E-04
51 to <61 years	1.7E-04	1.3E-04	1.3E-04	1.5E-04	1.6E-04	1.8E-04	2.0E-04	2.2E-04	2.9E-04	1.6E-04	1.2E-04	1.3E-04	1.4E-04	1.6E-04	1.8E-04	2.0E-04	2.1E-04	2.6E-04
61 to <71 years	1.6E-04	1.4E-04	1.4E-04	1.5E-04	1.6E-04	1.8E-04	1.9E-04	2.0E-04	2.7E-04	1.5E-04	1.2E-04	1.2E-04	1.3E-04	1.4E-04	1.6E-04	1.7E-04	1.8E-04	2.4E-04
71 to <81 years	1.7E-04	1.4E-04	1.5E-04	1.6E-04	1.7E-04	1.8E-04	1.9E-04	2.0E-04	2.6E-04	1.6E-04	1.2E-04	1.3E-04	1.4E-04	1.6E-04	1.7E-04	1.9E-04	2.0E-04	2.8E-04
81 years and older	1.8E-04	1.5E-04	1.6E-04	1.7E-04	1.8E-04	2.0E-04	2.1E-04	2.2E-04	2.5E-04	1.7E-04	1.3E-04	1.4E-04	1.5E-04	1.6E-04	1.8E-04	2.0E-04	2.1E-04	2.3E-04

Table C-7. Descriptive statistics for daily ventilation rate (m³/min-kg), adjusted for body weight, while performing activities within the specified activity category, by age and gender categories (continued)

Age Category	Daily Ventilation Rate (m ³ /min-kg) - Males, Adjusted for Body Weight									Daily Ventilation Rate (m ³ /min-kg) - Females, Adjusted for Body Weight								
	Mean	Percentiles							Maximum	Mean	Percentiles							Maximum
		5 th	10 th	25 th	50 th	75 th	90 th	95 th			5 th	10 th	25 th	50 th	75 th	90 th	95 th	
Moderate Intensity Activities (3.0 < METS ≤ 6.0)																		
Birth to <1 year	1.8E-03	1.4E-03	1.5E-03	1.6E-03	1.8E-03	1.9E-03	2.2E-03	2.3E-03	3.0E-03	1.9E-03	1.5E-03	1.5E-03	1.7E-03	1.9E-03	2.0E-03	2.3E-03	2.4E-03	2.8E-03
1 year	1.9E-03	1.4E-03	1.5E-03	1.7E-03	1.8E-03	2.0E-03	2.3E-03	2.5E-03	3.2E-03	1.9E-03	1.5E-03	1.6E-03	1.7E-03	1.9E-03	2.0E-03	2.2E-03	2.4E-03	3.2E-03
2 years	1.5E-03	1.2E-03	1.3E-03	1.4E-03	1.5E-03	1.7E-03	1.8E-03	2.0E-03	2.3E-03	1.6E-03	1.3E-03	1.3E-03	1.4E-03	1.6E-03	1.7E-03	1.9E-03	2.0E-03	2.6E-03
3 to <6 years	1.2E-03	8.0E-04	8.8E-04	1.0E-03	1.1E-03	1.3E-03	1.6E-03	1.7E-03	2.1E-03	1.1E-03	7.9E-04	8.5E-04	9.6E-04	1.1E-03	1.3E-03	1.5E-03	1.6E-03	1.9E-03
6 to <11 years	7.4E-04	5.0E-04	5.5E-04	6.2E-04	7.1E-04	8.3E-04	9.6E-04	1.0E-03	1.4E-03	7.2E-04	4.6E-04	5.1E-04	6.0E-04	7.1E-04	8.4E-04	9.4E-04	1.0E-03	1.4E-03
11 to <16 years	4.9E-04	3.6E-04	3.8E-04	4.2E-04	4.7E-04	5.5E-04	6.4E-04	6.8E-04	1.1E-03	4.4E-04	3.2E-04	3.4E-04	3.8E-04	4.3E-04	4.9E-04	5.5E-04	6.1E-04	9.9E-04
16 to <21 years	3.9E-04	2.8E-04	3.0E-04	3.3E-04	3.8E-04	4.3E-04	4.9E-04	5.2E-04	7.1E-04	3.6E-04	2.7E-04	2.8E-04	3.1E-04	3.5E-04	4.1E-04	4.6E-04	4.9E-04	6.5E-04
21 to <31 years	3.6E-04	2.4E-04	2.6E-04	3.0E-04	3.4E-04	4.0E-04	4.7E-04	5.1E-04	8.2E-04	3.3E-04	2.4E-04	2.5E-04	2.8E-04	3.2E-04	3.6E-04	4.2E-04	4.5E-04	6.6E-04
31 to <41 years	3.6E-04	2.4E-04	2.6E-04	3.0E-04	3.4E-04	4.0E-04	4.7E-04	5.2E-04	7.6E-04	3.2E-04	2.1E-04	2.3E-04	2.7E-04	3.0E-04	3.5E-04	4.1E-04	4.6E-04	7.1E-04
41 to <51 years	3.7E-04	2.5E-04	2.7E-04	3.1E-04	3.5E-04	4.1E-04	4.7E-04	5.2E-04	7.2E-04	3.3E-04	2.2E-04	2.4E-04	2.8E-04	3.2E-04	3.8E-04	4.4E-04	4.9E-04	6.2E-04
51 to <61 years	3.8E-04	2.6E-04	2.8E-04	3.1E-04	3.7E-04	4.3E-04	4.8E-04	5.5E-04	7.6E-04	3.4E-04	2.4E-04	2.5E-04	2.8E-04	3.3E-04	3.8E-04	4.4E-04	4.9E-04	6.4E-04
61 to <71 years	3.4E-04	2.7E-04	2.8E-04	3.1E-04	3.4E-04	3.7E-04	4.0E-04	4.2E-04	5.7E-04	2.9E-04	2.2E-04	2.4E-04	2.6E-04	2.8E-04	3.2E-04	3.5E-04	3.7E-04	5.1E-04
71 to <81 years	3.6E-04	2.9E-04	3.1E-04	3.3E-04	3.6E-04	3.9E-04	4.2E-04	4.4E-04	5.5E-04	3.1E-04	2.4E-04	2.5E-04	2.7E-04	3.0E-04	3.4E-04	3.8E-04	4.1E-04	6.8E-04
81 years and older	3.8E-04	3.1E-04	3.2E-04	3.5E-04	3.8E-04	4.2E-04	4.5E-04	4.7E-04	5.3E-04	3.3E-04	2.5E-04	2.7E-04	3.0E-04	3.3E-04	3.7E-04	4.0E-04	4.2E-04	5.2E-04

Table C-7. Descriptive statistics for daily ventilation rate (m³/min-kg), adjusted for body weight, while performing activities within the specified activity category, by age and gender categories (continued)

Age Category	Daily Ventilation Rate (m ³ /min-kg) - Males, Adjusted for Body Weight									Daily Ventilation Rate (m ³ /min-kg) - Females, Adjusted for Body Weight								
	Mean	Percentiles							Max	Mean	Percentiles							Max
		5 th	10 th	25 th	50 th	75 th	90 th	95 th			5 th	10 th	25 th	50 th	75 th	90 th	95 th	
High Intensity (METS > 6.0)																		
Birth to <1 year	3.5E-03	2.7E-03	2.9E-03	3.1E-03	3.5E-03	3.8E-03	4.1E-03	4.3E-03	5.1E-03	3.3E-03	2.5E-03	2.6E-03	2.9E-03	3.2E-03	3.6E-03	4.0E-03	4.1E-03	5.0E-03
1 year	3.5E-03	2.5E-03	2.9E-03	3.2E-03	3.6E-03	3.9E-03	4.1E-03	4.3E-03	4.9E-03	3.4E-03	2.6E-03	2.7E-03	3.0E-03	3.2E-03	3.7E-03	4.2E-03	4.9E-03	4.9E-03
2 years	2.9E-03	2.2E-03	2.3E-03	2.6E-03	2.9E-03	3.2E-03	3.4E-03	3.5E-03	4.3E-03	2.8E-03	2.2E-03	2.3E-03	2.5E-03	2.8E-03	3.1E-03	3.4E-03	3.5E-03	3.9E-03
3 to <6 years	2.2E-03	1.5E-03	1.7E-03	1.8E-03	2.1E-03	2.5E-03	2.7E-03	3.0E-03	3.6E-03	2.0E-03	1.4E-03	1.5E-03	1.7E-03	1.9E-03	2.2E-03	2.5E-03	3.0E-03	3.2E-03
6 to <11 years	1.4E-03	9.4E-04	1.0E-03	1.2E-03	1.4E-03	1.6E-03	1.8E-03	1.9E-03	2.7E-03	1.3E-03	8.9E-04	9.7E-04	1.1E-03	1.3E-03	1.5E-03	1.7E-03	1.8E-03	2.2E-03
11 to <16 years	9.5E-04	6.3E-04	7.0E-04	7.9E-04	9.1E-04	1.1E-03	1.3E-03	1.4E-03	2.0E-03	8.8E-04	5.9E-04	6.3E-04	7.1E-04	8.5E-04	1.0E-03	1.2E-03	1.3E-03	2.0E-03
16 to <21 years	7.1E-04	4.8E-04	5.3E-04	6.0E-04	6.9E-04	8.0E-04	9.2E-04	1.0E-03	1.9E-03	7.0E-04	4.5E-04	5.0E-04	5.7E-04	6.9E-04	7.9E-04	9.2E-04	1.0E-03	1.5E-03
21 to <31 years	6.6E-04	4.5E-04	4.7E-04	5.4E-04	6.4E-04	7.5E-04	8.5E-04	9.7E-04	1.3E-03	6.5E-04	4.2E-04	4.6E-04	5.5E-04	6.3E-04	7.3E-04	8.8E-04	9.4E-04	1.3E-03
31 to <41 years	6.4E-04	4.4E-04	4.7E-04	5.3E-04	6.2E-04	7.3E-04	8.5E-04	9.3E-04	1.2E-03	6.1E-04	3.8E-04	4.2E-04	5.0E-04	5.9E-04	7.1E-04	8.3E-04	9.0E-04	1.5E-03
41 to <51 years	6.6E-04	4.4E-04	4.8E-04	5.5E-04	6.3E-04	7.4E-04	8.6E-04	9.4E-04	1.8E-03	6.5E-04	3.8E-04	4.4E-04	5.2E-04	6.4E-04	7.6E-04	8.8E-04	9.5E-04	1.6E-03
51 to <61 years	6.8E-04	4.5E-04	4.8E-04	5.5E-04	6.4E-04	7.7E-04	9.1E-04	1.0E-03	1.3E-03	6.3E-04	3.9E-04	4.3E-04	5.1E-04	6.1E-04	7.5E-04	8.5E-04	9.3E-04	1.4E-03
61 to <71 years	6.2E-04	4.4E-04	4.7E-04	5.3E-04	6.1E-04	7.0E-04	7.9E-04	8.5E-04	1.1E-03	5.4E-04	3.6E-04	4.0E-04	4.5E-04	5.3E-04	6.1E-04	7.2E-04	8.0E-04	1.1E-03
71 to <81 years	6.5E-04	4.7E-04	5.0E-04	5.5E-04	6.3E-04	7.2E-04	8.5E-04	9.1E-04	1.0E-03	5.9E-04	3.9E-04	4.4E-04	5.0E-04	5.8E-04	6.8E-04	7.8E-04	8.3E-04	1.3E-03
81 years and older	7.2E-04	5.0E-04	5.4E-04	6.0E-04	7.0E-04	8.0E-04	9.4E-04	9.9E-04	1.4E-03	6.7E-04	4.5E-04	4.8E-04	5.4E-04	6.3E-04	7.7E-04	9.3E-04	9.7E-04	1.2E-03

C-31

Individual measures are weighted by their 4-year sampling weights as assigned within NHANES 1999–2002 when calculating the statistics in this table. Ventilation rate was estimated using the multiple linear regression model in Section 3.6.

APPENDIX D

**RESPONSE PREPARED BY S. GRAHAM (U.S. EPA)
TO PEER-REVIEW COMMENTS ON APPENDIX A**

TABLE OF CONTENTS

1.	Purpose	D-4
2.	APEX Model Description	D-4
3.	Ventilation Algorithm Evaluation	D-5
4.	Comparison of APEX Estimates with Brochu et al. (2006a, b)	D-6
5.	Results of Comparison of APEX Estimates with Brochu et al. (2006a, b)	D-6
6.	Conclusions of Brochu et al. (2006a, b) Comparison	D-11
7.	Comparison of APEX Estimates with Arcus-Arth and Blaisdell (2007)	D-12
8.	Results of Comparison of APEX Estimates with Arcus-Arth and Brochu et al. (2006a, b)	D-13
9.	Issues.....	D-13
10.	Conclusions of Arcus-Arth and Blaisdell (2007) Comparison	D-13
11.	References to Appendix D	D-15

LIST OF FIGURES

D-1.	Body mass comparison	D-7
D-2.	Mean resting energy expenditure comparison	D-8
D-3.	Comparison of body mass normalized mean basal energy expenditure (BEE-kg).	D-8
D-4.	Comparison of mean total daily energy expenditure (EE).....	D-9
D-5.	Comparison of mean physical activity level (PAL).....	D-10
D-6.	Comparison of mean daily ventilation rate (V_E).....	D-10
D-7.	Comparison of body mass normalized mean daily ventilation rate (V_E -kg)	D-11
D-8.	Comparison of body mass normalized mean ventilation rates (V_E -kg) correcting Brochu et al. (2006a) results with child appropriate VQ estimates	D-12
D-9.	Comparison of mean daily ventilation rate (V_E) in children	D-14
D-10.	Comparison of body mass normalized mean ventilation rates (V_E -kg) in children.....	D-14

1. Purpose

This appendix addresses comments provided by external peer reviewers on Appendix A of this document. In particular, clarification of how U.S. EPA's Air Pollutants Exposure (APEX) model can be used to estimate ventilation rates is provided, and model ventilation estimates are compared with recently published estimates of ventilation rate.

2. APEX Model Description

U.S. EPA (2008a, b) provides more details on the approach to estimating ventilation rates using APEX. To summarize, the model is designed to estimate exposure to air pollutants and inhalation dose, accounting for the expected variability in both human behavior and physiology through consideration of important influential characteristics. One noteworthy feature of the model is its ability to estimate a time-series of exposure and dose for simulated individuals by correlating the time-series of microenvironmental concentration with the time series of activity-specific ventilation rates that could be as short as 1 minute in duration.

Briefly, any number of individuals can be simulated in a model run to estimate exposure and exposure-related metrics (e.g., ventilation rate, body mass). Personal attributes of a simulated individual are first estimated (e.g., body mass, basal energy expenditure [BEE]) using either measurement data distributions (e.g., body mass distributions from CDC) or equations derived from measurement data and reported in the peer-reviewed literature (e.g., EE from Schoefield, 1985). Human time-location-activity diaries in U.S. EPA's Consolidated Human Activity Database (CHAD) (McCurdy et al., 2000; U.S. EPA, 2002) are used to generate activity profiles for the simulated individuals for periods as short as one day upwards to a year. Each activity has a distribution of Metabolic Equivalents of work (METS) (e.g., point, lognormal, normal) that is sampled to estimate activity-specific METS for the individual performing the given activity. That combined with body mass dependent EE and a conversion for energy expenditure to oxygen consumption (e.g., H in Brochu et al., 2006a) result in activity-specific VO_2 (typically in L- O_2 /min). These data are used as inputs to the regression equations reported in Appendix A (along with age, gender, and body mass) to estimate ventilation rate (V_E , L/min). There are greater details in the approach such as those regarding adjusting the MET time-series to account for fatigue therefore regulating the duration of vigorous activities and excess

postexercise oxygen consumption whereby oxygen consumption is increased to repay oxygen debt that may have incurred from vigorous activities. See U.S. EPA (2008a, b) for more details.

3. Ventilation Algorithm Evaluation

Two recent publications were identified as potentially useful in the evaluation of the ventilation algorithm. Brochu et al. (2006a) presents data for ventilation rates, body mass, and energy expenditure for comparison, derived from data reported in studies that used the doubly-labeled water (DLW) method to estimate energy expenditure. Important reported subject characteristics include both genders, ages from 1 month to 96 years, and disaggregated by body mass (overweight/obese, normal body mass). For example, overweight individuals were defined as having body mass indexes (BMI) above the 97th percentiles for infants and toddlers <3 years, >85th percentile for children under 20, and BMI >25 for adults above 19 years old. Estimates of energy expended were combined with a fixed oxygen uptake factor ($H = 0.21$) and a fixed ventilatory equivalent ($VQ = V_E/VO_2 = 27$), while also accounting for stored daily energy cost for growth up to age 24, although this cost is generally only about 2% of total energy expended for ages above 1 year old. The DLW measurement generally extended from 7–21 days, resulting in time-averaged metrics that provide reasonable estimates for the mean (e.g., mean daily ventilation rate), but are not useful for estimating variability in an individual's ventilation rate (or other parameter) over shorter time periods. Reported data are averages for several age groupings (e.g., 1–<2, 2–<5, 5–<7, etc.) with derived percentiles assuming a normal distribution. Arcus-Arth and Blaisdell (2007) provide ventilation estimates for children <19 years of age using energy intake (EI, or calories consumed) and body mass data provided from the U.S. Department of Agriculture's (USDA) Continuing Survey of Food Intake for Individuals (CSFII), adjusted for underreporting of food intakes ($\times 1.2$ for children >8 years) and stored energy in infants alone (<1 years old). Two-day daily average EIs were combined with H (i.e., 0.22 for infants, 0.21 for non infants) and VQ (i.e., 33.5 for children 0–8, 30.6 for boys 9–18, 31.5 for girls 9–18 years old). Again, time-averaging of the data provide reasonable estimates of the mean, but offer no variability in ventilation estimates for time periods of shorter duration. Furthermore, data for both genders are combined and reported by age, with gender differences reported only for aggregated age groups (males and females, 9–18 years old). Additional gender-specific age groupings are reported for comparison with other literature values, however

are limited in number to be of great use here. An APEX model simulation was performed to generate estimates of relevant parameters for comparison with some of the estimates reported in these two publications.

4. Comparison of APEX Estimates with Brochu et al. (2006a, b)

A 14-day simulation was performed (i.e., the median of 7–21 days for the DLW data) for comparison with the time averaged Brochu et al. (2006a) data. Twenty-five thousand persons were simulated by APEX to generate a reasonable number of persons within each year of age and other potential categorical variables (e.g., 100–200, although some age groups have only 1–5 persons). It is important when comparing the two types of data to have them as similar as possible, particularly since age and body mass are important influential variables. Body mass and height estimates were used to calculate BMIs for use in identifying normal versus overweight individuals as was done for the Brochu et al. (2006a) data. Percentiles for BMI of children ages 2–20 were obtained from CDC (2000). Children ≤ 2 years old were classified as overweight based on whether or not they exceeded the 97th percentile for 2-year olds of the same gender (there were no data reported by CDC for ages less than 2 years), while children aged 3–20 years were classified as overweight if they exceeded the 85th percentile. Adults were classified as overweight if their BMI ≥ 25.0 . A total of 9,613 normal-weight individuals were simulated by APEX and used for the following analysis. Multi-day parameter estimates (e.g., ventilation rates, physical activity level, or PAL) were time averaged across the 14-day simulation period, yielding a mean daily value for each person to best represent the DLW time averaging done in Brochu et al. (2006a).

5. Results of Comparison of APEX Estimates with Brochu et al. (2008a, b)

Figure D-1 compares the mean body mass (BM, kg) estimates of APEX simulated individuals by one year age intervals with the mean body mass reported in Table 2, page 684 of Brochu et al. (2006a) for several age groupings of normal-weight individuals. There are no apparent differences in the population reported by Brochu et al. (2006a) and the APEX simulated population regarding body mass.

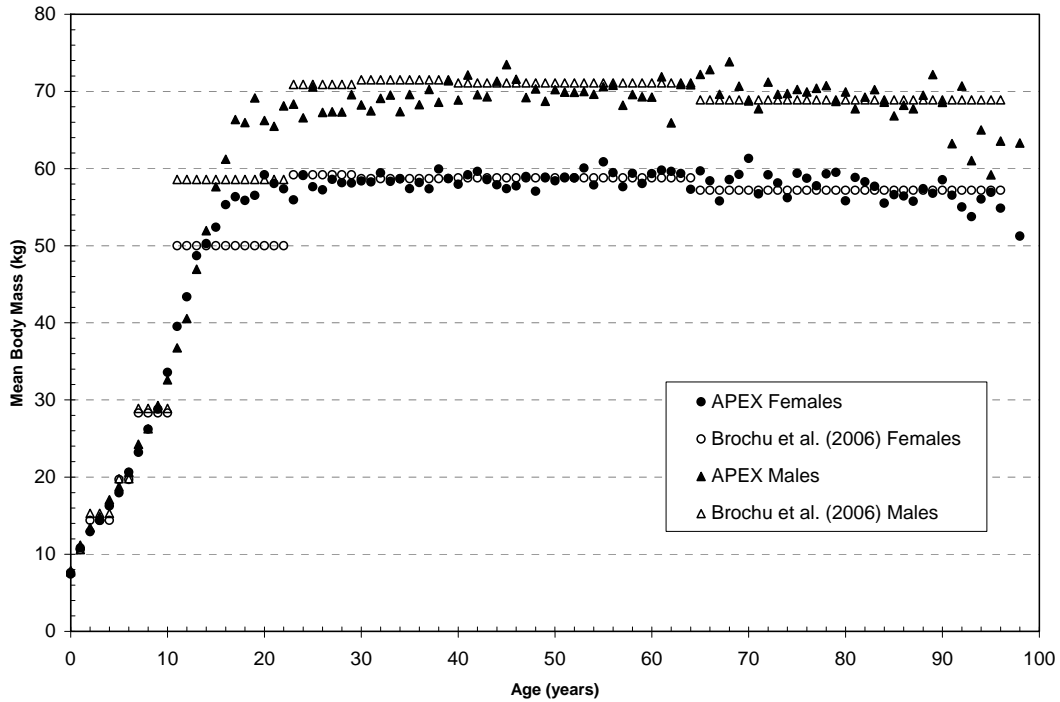

Figure D-1. Body mass comparison.

Figure D-2 compares the mean basal energy expenditure (BEE, Kcal/day) estimates of APEX simulated individuals by one year age intervals with the mean daily BEE reported in Table Web-3, page 3 of Brochu et al. (2006b) for several age groupings of normal-weight individuals. Little differences exist in the population reported by Brochu et al. (2006b) and the APEX simulated population regarding BEE.

Figure D-3 compares the mean body mass normalized basal energy expenditure (BEE-kg, Kcal/day-kg) estimates of APEX simulated individuals by one year intervals and those reported in Table Web-3m, page 3 of Brochu et al. (2006b) for several age groupings of normal-weight individuals. Little difference exists in the population reported by Brochu et al. (2006b) and the APEX simulated population regarding BEE-kg.

Figure D-4 compares the mean daily energy expenditure (EE, Kcal/day) estimates of APEX simulated individuals by one year age intervals and those reported in Table Web-3, page 3 of Brochu et al. (2006b) for several age groupings of normal-weight individuals. Little difference exists in the population reported by Brochu et al. (2006b) and the APEX simulated population regarding EE for ages less than 15, APEX estimates of EE are higher by about 10% for both genders at greater ages.

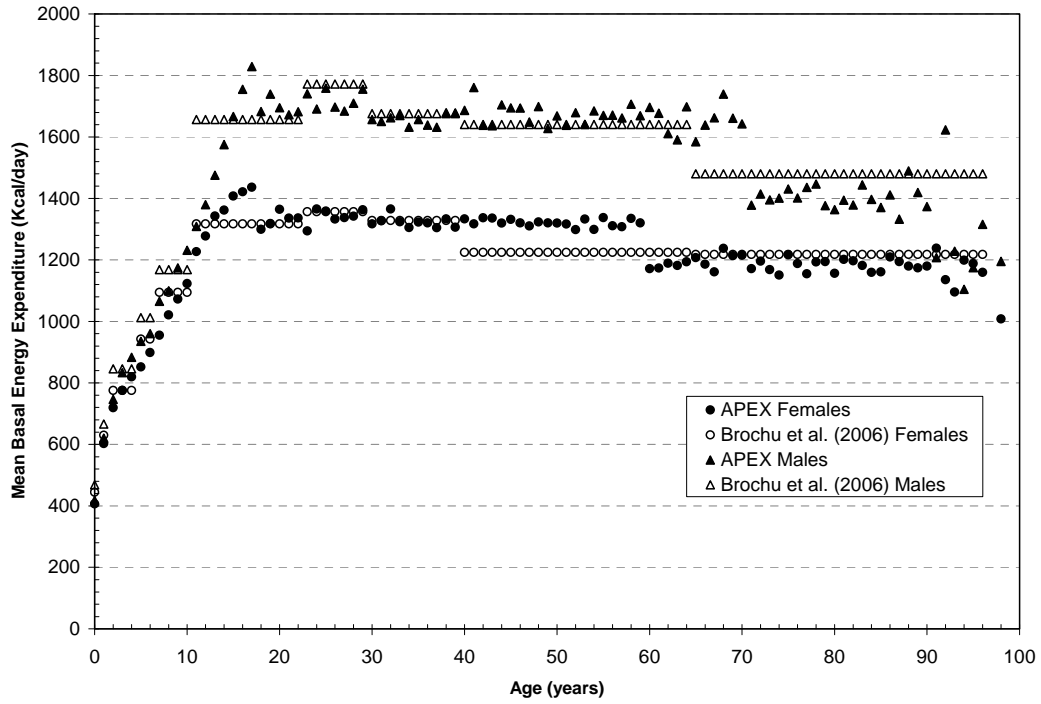

Figure D-2. Mean resting energy expenditure comparison.

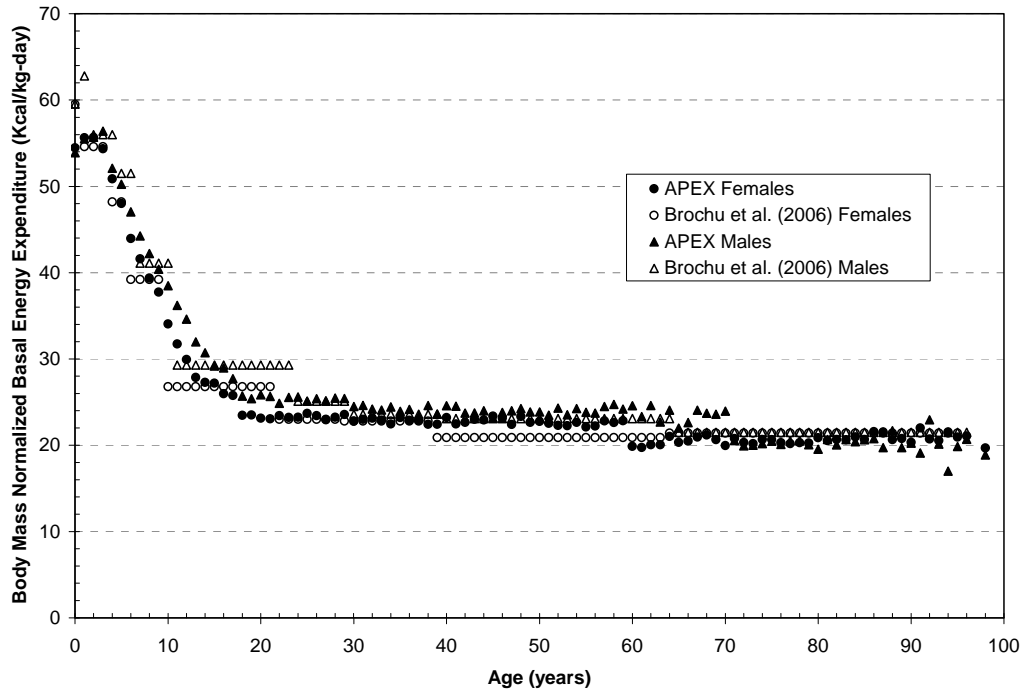

Figure D-3. Comparison of body mass normalized mean basal energy expenditure (BEE-kg).

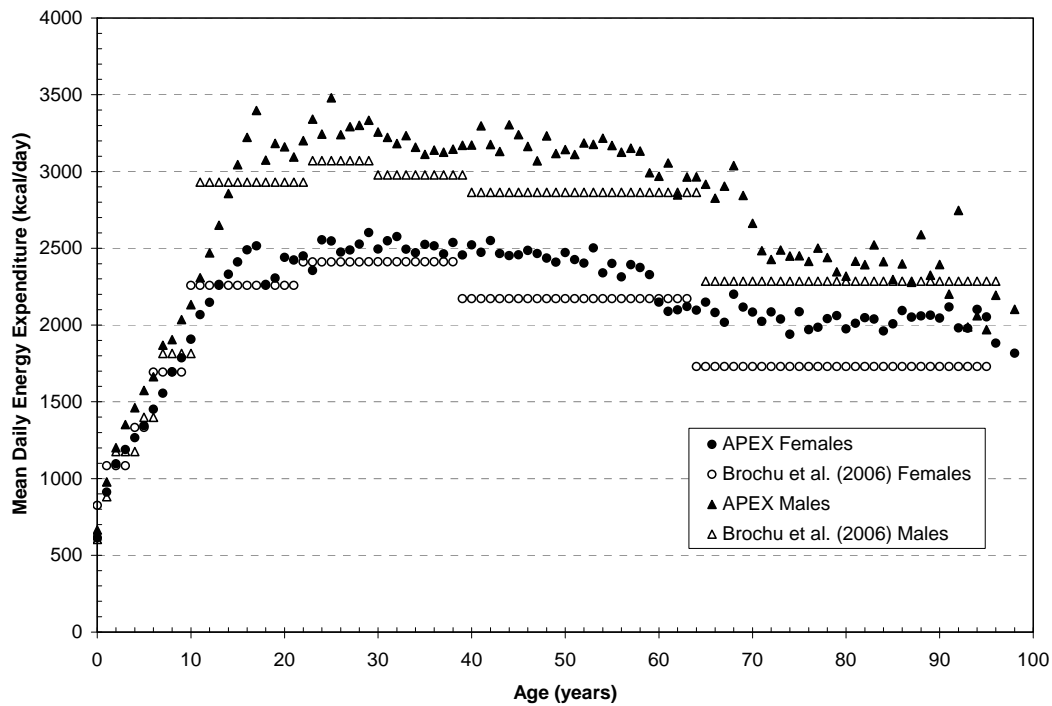

Figure D-4. Comparison of mean total daily energy expenditure (EE).

Figure D-5 compares the mean physical activity levels (PAL, unitless) estimated by APEX simulated individuals by one year age intervals and those reported in Table Web-3, page 3 of Brochu et al. (2006b) for several age groupings of normal-weight individuals. Little difference exists in the population reported by Brochu et al. (2006b) and the APEX simulated population regarding PAL for ages between 10 and 20. APEX estimates of PAL are higher for both genders at other ages when compared with similar age PAL estimates from Brochu et al. (2006a, b), most notably at ages above 64.

Figure D-6 compares the mean daily ventilation rate (V_E , m^3/day) estimates of APEX simulated individuals by one year age intervals with those reported in Table 2, page 684 of Brochu et al. (2006a) for several age groupings of normal-weight individuals. The results were mixed for several ages and both genders when comparing those reported by Brochu et al. (2006a) and the APEX simulated population. APEX estimations were higher for children (age <11) and the elderly (age >64), while Brochu et al. (2006a) estimates were generally higher for males age 12–40 and females age 18–40. For the young children, this may be a function of the fixed VQ used by Brochu et al. (2006 a, b) (see below).

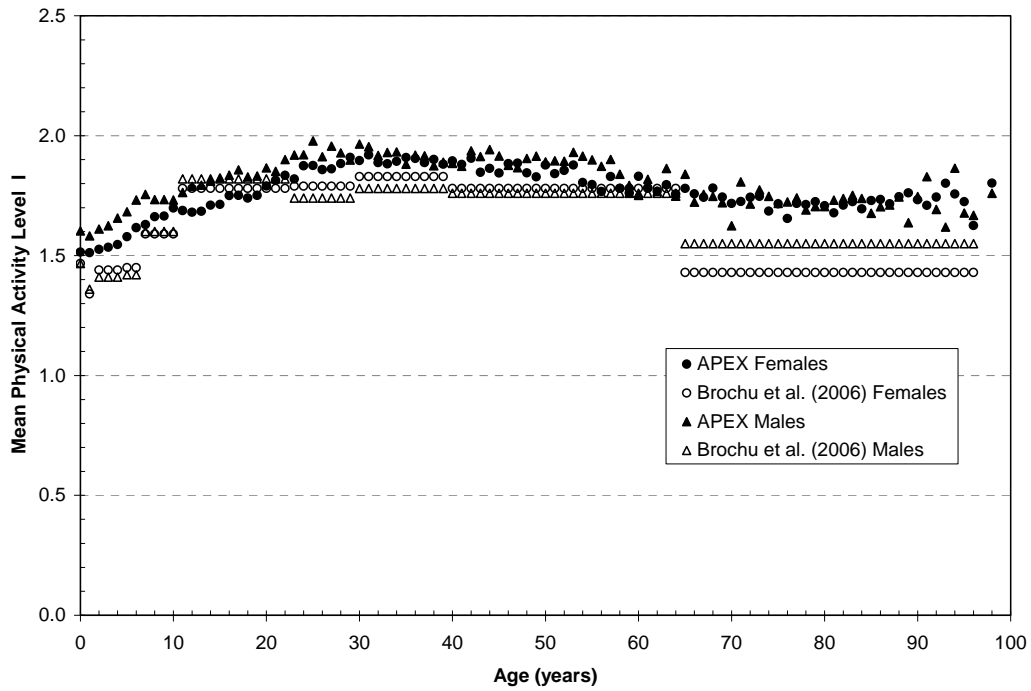

Figure D-5. Comparison of mean physical activity level (PAL).

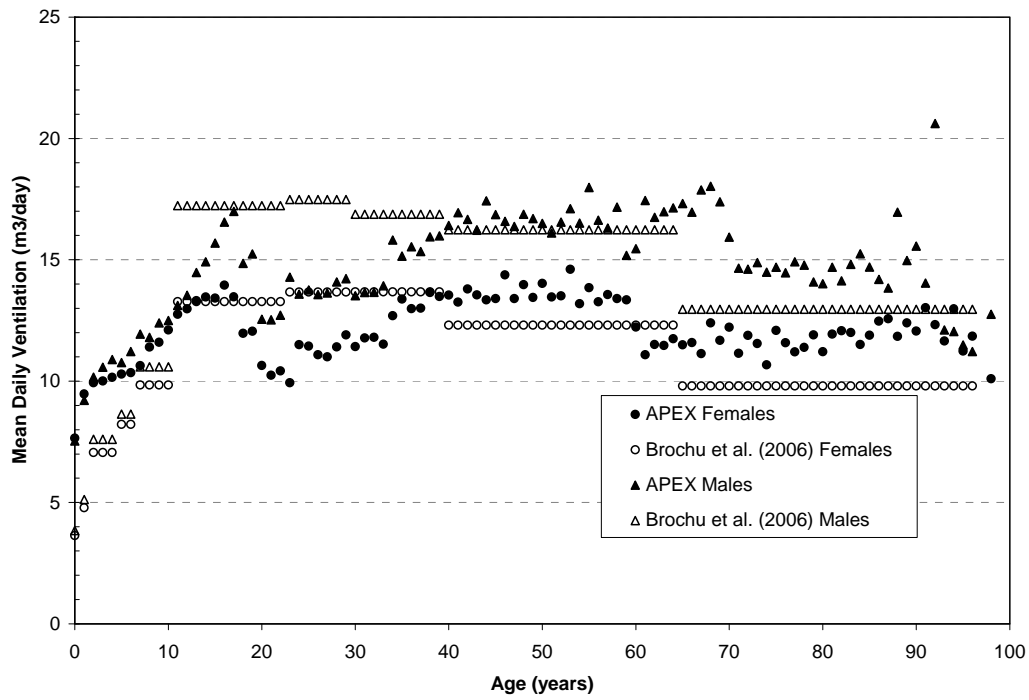

Figure D-6. Comparison of mean daily ventilation rate (V_E).

Figure D-7 compares the body mass normalized mean daily ventilation rate ($V_{E\text{-kg}}$, $\text{m}^3/\text{day}\cdot\text{kg}$) estimates of APEX simulated individuals by one year age intervals with those reported in Table 2, page 684 of Brochu et al. (2006a) for several age groupings of normal-weight individuals. The two largest differences appear for children of both genders less than age 10 (Brochu et al., [2006a] estimates are systematically lower than APEX estimates) and ages between 16–33 (APEX estimates are lower than Brochu et al., [2006a]). Body mass normalized ventilation rates also appear to be slightly higher using APEX for ages above 64, both genders.

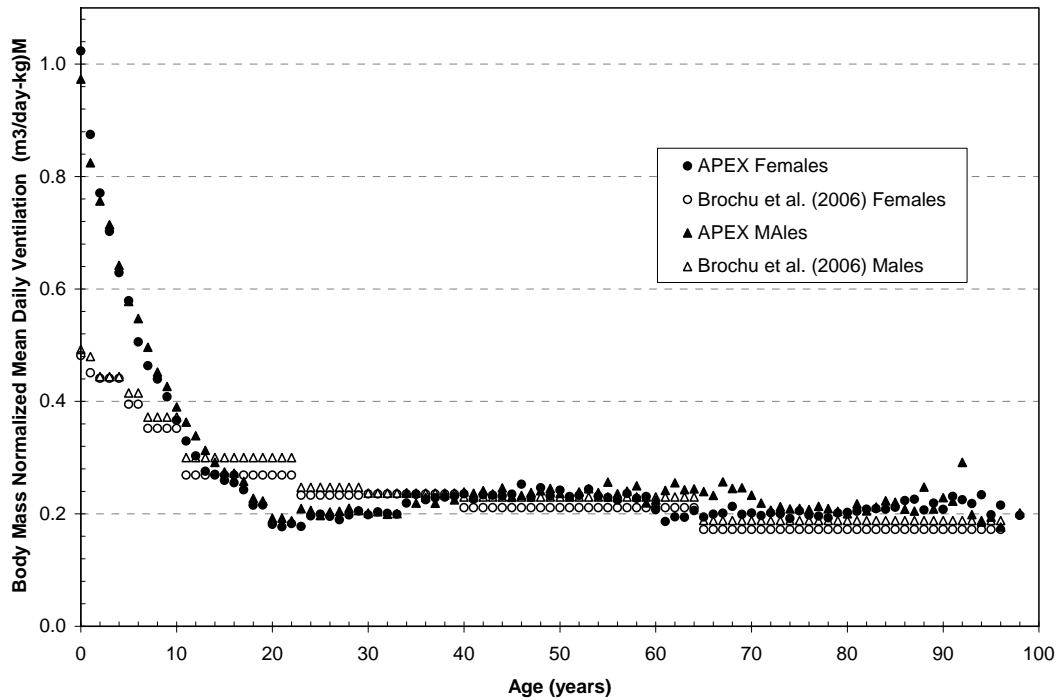

Figure D-7. Comparison of body mass normalized mean daily ventilation rate ($V_{E\text{-kg}}$).

6. Issues

One principal issue identified as responsible for some of the noted differences in ventilation estimates is in the VQ used by Brochu et al. (2006a). A single value of 27 was used in estimating ventilation rates for both children and adults, however it is widely recognized that while a VQ of 27 may be a reasonable approximation for estimating mean ventilation rates of adults, it is not appropriate for use in estimating mean ventilation rates in children. With this in

mind, the Brochu et al. (2006a) ventilation estimates were modified here using the VQ estimates offered by Arcus-Arth and Blaisdell (2007). Figure D-8 illustrates the comparison of APEX body mass normalized mean daily ventilation rates with that of Brochu et al. (2006a) corrected ventilation estimates. The body mass normalized ventilation estimates for children are more similar to those generated by APEX when correcting the Brochu et al. (2006a) VQ parameter.

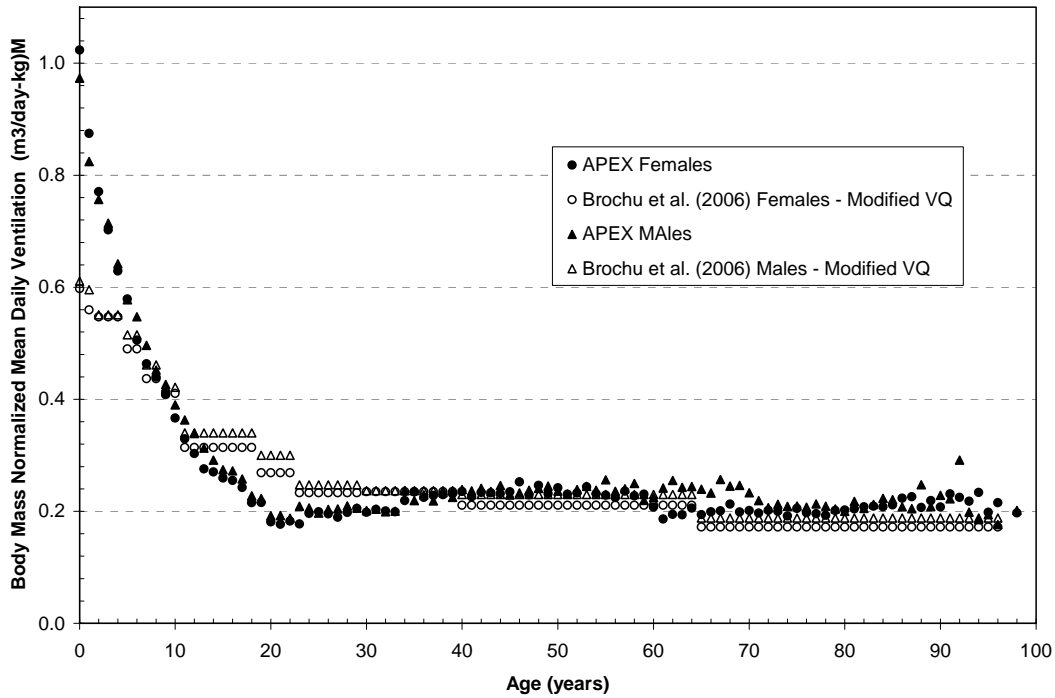

Figure D-8. Comparison of body mass normalized mean ventilation rates (V_E -kg) correcting Brochu et al. (2006a) results with child appropriate VQ estimates.

7. Conclusions of Brochu et al. (2006a, b) Comparison

Mean estimates for all of the physiological parameters generated by APEX including ventilation rates are reasonably correlated with independent measures from the Brochu et al. (2006a, b) estimates, particularly when correcting the Brochu et al. (2006a) ventilation estimates for children using a more appropriate estimate of VQ for children.

8. Comparison of APEX Estimates with Arcus-Arth and Blaisdell (2007)

A 2-day model simulation was performed using APEX to generate ventilation estimates (total ventilation and body mass normalized) for children to compare with results of Arcus-Arth and Blaisdell (2007). Table II (page 102) of Arcus-Arth and Blaisdell (2007) provided daily ventilation estimates, while Table III (page 103) provided body mass normalized ventilation rates. APEX ventilation estimates were time-averaged to generate mean daily values, and since the data reported in Arcus-Arth and Blaisdell (2007) were not separated by gender (outside of broad age categories), the APEX estimates were also combined to provide a mean estimate for each year of age (0–18). Body mass was also not used as a categorical variable in Arcus-Arth and Blaisdell (2007), therefore all APEX simulated individuals were used, regardless of whether they could be classified as overweight or of normal weight. In addition, data were obtained from Tables 3 and 4 of Brochu et al. (2006a) for a few age categories and considering both estimates for normal and overweight individuals (there were no combined data available). The Brochu et al. (2006 a, b) results have been corrected for VQ as noted above using VQ estimates of Arcus-Arth and Blaisdell (2007).

9. Results of Comparison of APEX Estimates with Arcus-Arth and Brochu et al. (2006a, b)

Figures D-9 and D-10 illustrate ventilation rate estimates from the APEX simulation, along with relevant data for children (ages 0–18) obtained from the two papers. Mean daily ventilation estimates (Figure D-9) are quite similar at each year of age, with slightly higher estimates by Arcus-Arth and Blaisdell (2007) at ages 9 and above, particularly when compared with APEX ventilation estimates. When ventilation rate is normalized by body mass (Figure D-10), the largest difference occurs at ages less than 4, whereas APEX estimates are higher than Arcus-Arth (2007), possibly influenced by differences in body mass between the two sample populations, particularly between ages 0 and 1.

10. Conclusions of Arcus-Arth and Blaisdell (2007) Comparison

Ventilation estimates are remarkably similar for children for all three sources of data, particularly when considering the differences in the type of input data used and the varied approaches of APEX, Brochu et al. (2006 a, b), and Arcus-Arth and Blaisdell (2007).

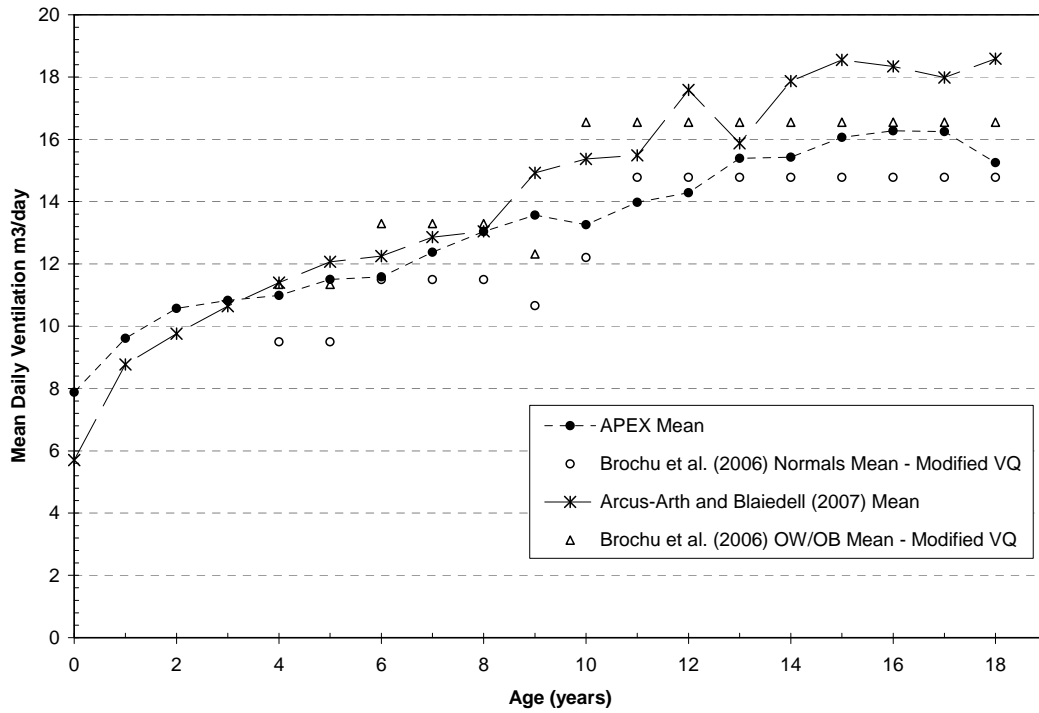

Figure D-9. Comparison of mean daily ventilation rate (V_E) in children.

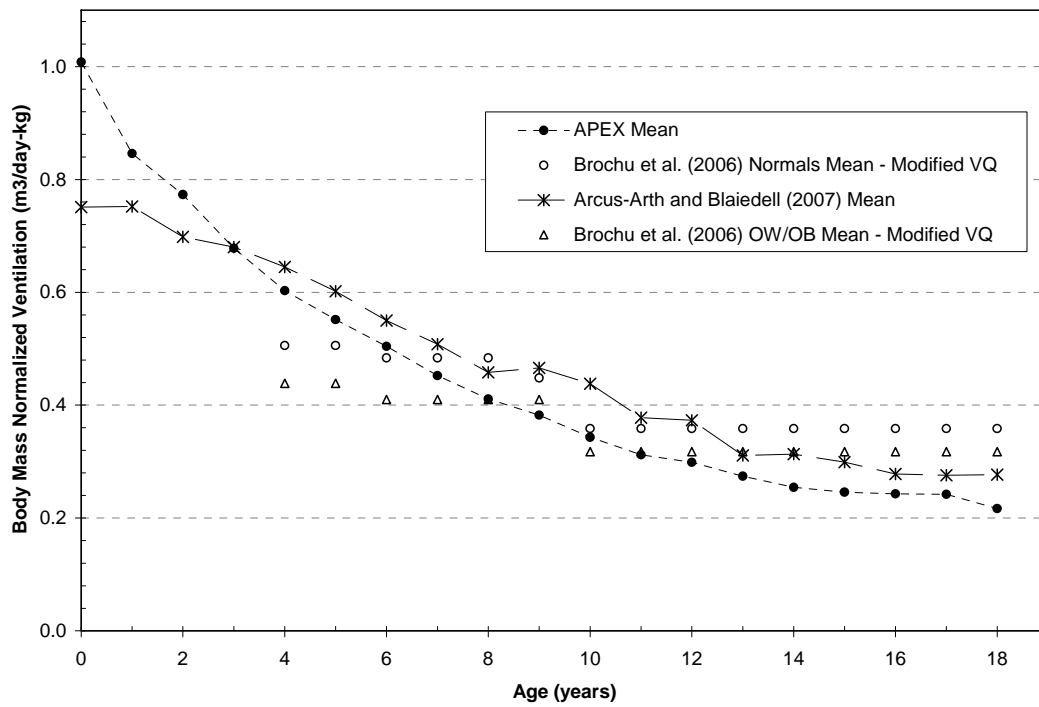

Figure D-10. Comparison of body mass normalized mean ventilation rates (V_E -kg) in children.

11. References to Appendix D

- Arcus-Arth, A; Blaisdell, J. (2007). Statistical distributions of daily breathing rates for narrow age groups of infants and children. *Risk Anal* 27(1):97–110.
- Brochu, P; Ducre-Robitaille, J-F ; Brodeur, J. (2006a) Physiological daily inhalation rates for free-living individuals aged 1 month to 96 years, using data from doubly labeled water measurements: a proposal for air quality criteria, standard calculations and health risk assessment. *Hum Ecol Risk Assess* 12(4):675–701.
- Brochu, P; Ducre-Robitaille, J-F; Brodeur, J. (2006b) Supplemental Material for Physiological daily inhalation rates for free-living individuals aged 1 month to 96 years, using data from doubly labeled water measurements: a proposal for air quality criteria, standard calculations and health risk assessment. *Hum Ecol Risk Assess* 12(4):1–12.
- CDC (Centers for Disease Control and Prevention). (2000). CDC Growth Charts: United States. BMI-for-age charts. National Center for Health Statistics, Hyattsville. Available online at <http://www.cdc.gov/nchs/about/major/nhanes/growthcharts/datafiles.htm>.
- McCurdy, T; Glen, G; Smith, L; et al. (2000) The National Exposure Research Laboratory's consolidated human activity database. *J Expo Anal Environ Epidemiol* 10:566–578.
- Schofield, W.N. 1985. Predicting basal metabolic rate, new standards and review of previous work. *Hum. Nutr. Clin. Nutr.*, 39C (suppl. 1): 5-41.
- U.S. EPA Environmental Protection Agency) (2002) Consolidated Human Activities Database. Office of Research and Development, National Exposure Research Laboratory, Washington, DC. Available online at <http://www.epa.gov/chadnet1/>.
- U.S. EPA (2008a). Total Risk Integrated Methodology (TRIM) - Air Pollutants Exposure Model Documentation (TRIM.Expo / APEX, Version 4) Volume I: User's Guide. Office of Air Quality Planning and Standards, U.S. Environmental Protection Agency, Research Triangle Park, NC. June 2006. Available online at http://www.epa.gov/ttn/fera/human_apex.html.
- U.S. EPA (2008b). Total Risk Integrated Methodology (TRIM) - Air Pollutants Exposure Model Documentation (TRIM.Expo / APEX, Version 4) Volume II: Technical Support Document. Office of Air Quality Planning and Standards, U.S. Environmental Protection Agency, Research Triangle Park, NC. June 2006. Available online at http://www.epa.gov/ttn/fera/human_apex.html.